

Tire Catalogue

Truck and Bus

Enjoy Driving



TRUCK & BUS TIRES 2023

Giti truck tires provide diverse tire solutions to meet the needs of various road conditions and driving habits for commercial customers. Giti knows that durability, safety, and efficiency are paramount to companies that need to succeed in daily business while lowering expenses, and we focus our efforts on providing positive solutions to the needs of clients.

Giti is committed to helping transportation companies achieve sustainable transportation with very efficient tires. Giti truck and bus tires are available to meet your business needs. On the following pages you will find the patterns that are currently available.



CONTENTS

Company Profile

Truck & Bus Tires	2
Corporate Social Responsibilities	4
Why Buy Giti Tires?	6
A Singapore Based Global Tire Company	7
Giti Tire Worldwide Group Information	8
World Class Manufacturing Facilities	10
Quality and Accreditation	11
Giti Competition Truck Racing	12
Product Application Overview	14

Product Offer

COMBI ROAD	16
ECO ROAD	34
LONG HAUL	38
REGIONAL	48
MIXED SERVICE & ON/OFF	54
URBAN	64
WINTER	72
GENESIS RETREADS	79

Tire Basics

Retreading	78
Designations, Load and Speed Index	82
Naming Conventions	83

Tire Management, Care & Maintenance

Six Steps to Simple Tire Maintenance	84
Tire Pressure Management	85
Technical Specifications	86
Essential Safety Information	87
Winter Regulation	88
Labelling Explained	90

EU Labelling	92
---------------------	----

Technical Data	96
-----------------------	----

Giti Tires: Designed for Long-term Use	102
---	-----

Regrooving Instructions	103
--------------------------------	-----

CORPORATE SOCIAL RESPONSIBILITIES

MISSION & COMMITMENT

Giti Tire endorses the United Nations Sustainable Development Goals (SDGs) and incorporates them into each CSR activity. These goals cover a broad range of social and economic development issues. Included among them are poverty, hunger, health, education, climate change, gender equality, water sanitation, energy, environment, and social justice.



REDUCE
Thanks to our design approach, our tires are lighter, consume less energy and last longer.

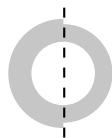

RENEW
We use eco_design materials from renewable resources.

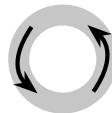

REUSE
Our tires are repairable, regroovable, retreadable.



RECYCLE
We incorporate recycled materials into our new tires.



UNGC MEMBERSHIP

As part of the United Nations, the UNGC is a highly respected and important global business agreement, that requires a CEO and company commitment to adhering to the Ten Principles of the United Nations, including human rights, labor, environment, and anti-corruption. Giti is proud to join this exclusive and important compact in 2021, and continue to grow with it through an annual Communication on Progress, as well as other commitments.

Further details about the United Nations Global Compact can be seen on their website here



GPSNR MEMBERSHIP

Giti Tire is proud to be a member of GPSNR (Global Platform for Sustainable Natural Rubber), a leading global organization dedicated to maintaining a fair, equitable, and environmentally sound natural rubber value chain. As tires directly relate to the environment, a focus on improving the process of rubber creation, procurement, and supply is very important to reducing societal impact and creating positive offsetting solutions for the industry.

You can learn more about Giti's environmental and other sustainable efforts at



1 > GREEN ENERGY
Giti utilizes alternative and clean energy methods, including solar panels to generate green electricity.

3 > FUEL-GAS DESULFURIZATION (FGD)
The desulfurization efficiency rate now exceeds 95%, reducing 190 tons since the previous year.

2 > WATER RECYCLING
Continued recycling of water usage at Giti's plants has improved local environments.

4 > GREEN CERTIFICATIONS
Giti's plants throughout the world have received environmental management certification and passed clean production audits.



WHY BUY GITI TIRES?

GITI BRAND TIRES FOCUS PRIMARILY ON QUALITY – PROVIDING COMFORTABLE, DURABLE, AND ADAPTABLE TIRES FOR ALL APPLICATIONS.



A FOCUS ON PRODUCTION AND QUALITY MANAGEMENT

In each of Giti's eight tire plants, the company sets the highest standard of quality procedures. A highly stringent quality control system and concern for safety and quality demands in regions across the globe separate the brand from the competition.



TOP CLASS R&D FACILITIES & PERSONNEL

A team of over 700 experienced R&D engineers in five cutting-edge facilities around the world and top quality equipment ensure the utmost quality of tire production and delivery.



AWARDS AND RECOGNITION FROM THE BEST

The company has earned extensive recognition from highly credited organisations around the world and some of the automotive industry's largest names, including multiple top-supplier awards from General Motors.



RESPECT AROUND THE WORLD

Giti Tire products are trusted by all types of individuals, from the everyday driver to top motorsports performers. Through top performance and an extensive dealer network, the brand has a reputation for quality, performance, and safety.



A GREATER MISSION

Giti Tire has an environmental and humanitarian drive that ties into all its actions. The company focuses on multiple areas to properly educate people about driving and tire care, reducing energy consumption and pollution, as well as providing financial resources to help make the world a better place.

A SINGAPORE BASED GLOBAL TIRE COMPANY

GITI TIRE HAS BEEN IN THE TIRE BUSINESS FOR MORE THAN 60 YEARS. THE COMPANY HAS BECOME ONE OF THE WORLD'S LARGEST TIRE MANUFACTURERS, SERVING CUSTOMERS IN MORE THAN 130 COUNTRIES.

5th

LARGEST TRUCK TIRE MANUFACTURER
in the world

5

PLANTS

3 in China, 1 in Indonesia,
and 1 in the USA

11

OFFICES

Singapore, Indonesia,
Malaysia, China, U.S., Canada,
U.K., Germany, France,
Dubai and Brazil

3.0

billion USD
2021 REVENUE

11

R&D AND TESTING CENTRES

4 R&D in Germany, USA, China, Indonesia, and 7 testing centres in the UK, Spain, Finland, USA, China, Taiwan & Indonesia

More than

70,000

POINTS OF SALE

in more than 130 countries

More than

30,000

EMPLOYEES

worldwide



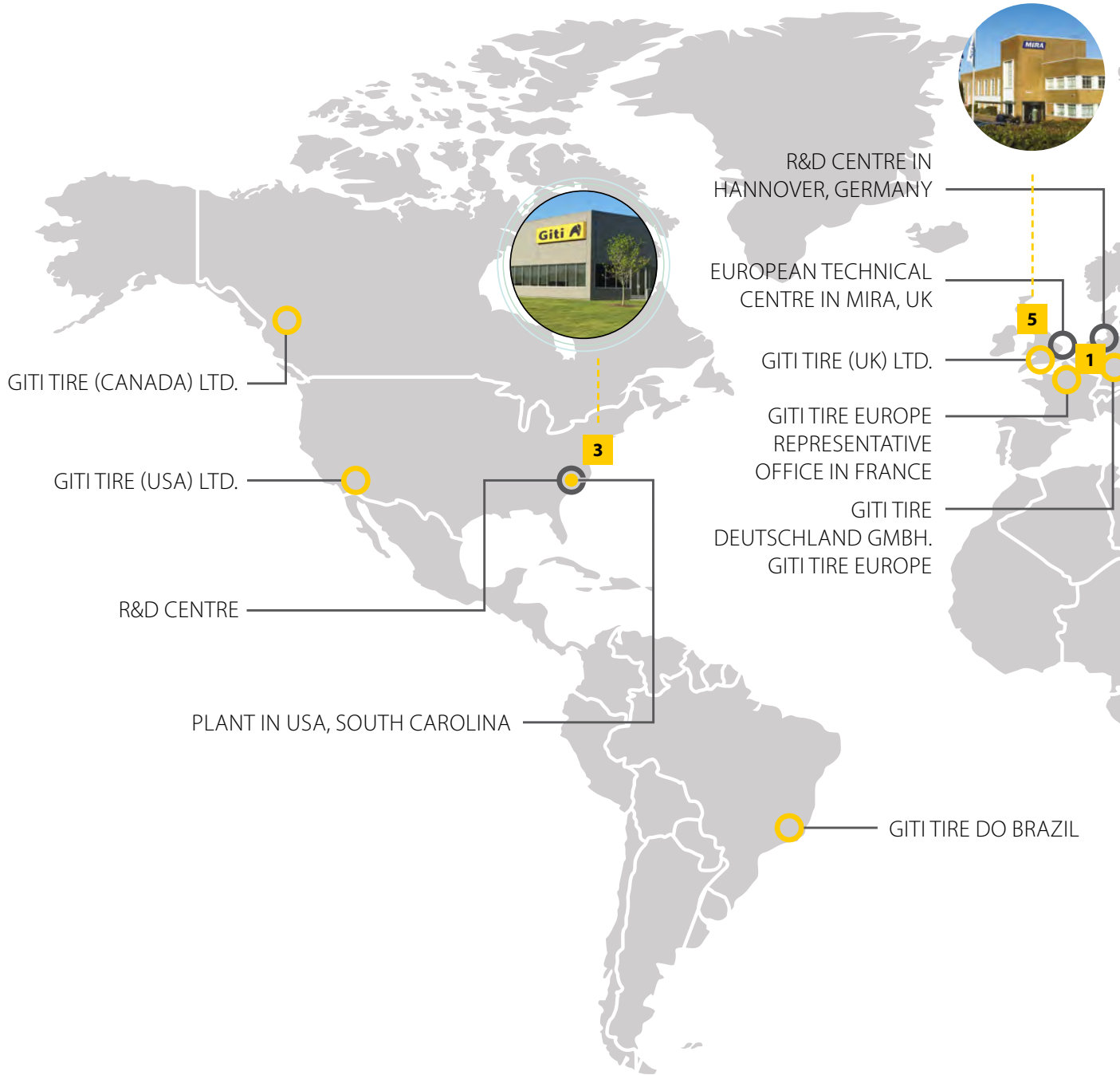

GITI TIRE WORLDWIDE GROUP INFORMATION

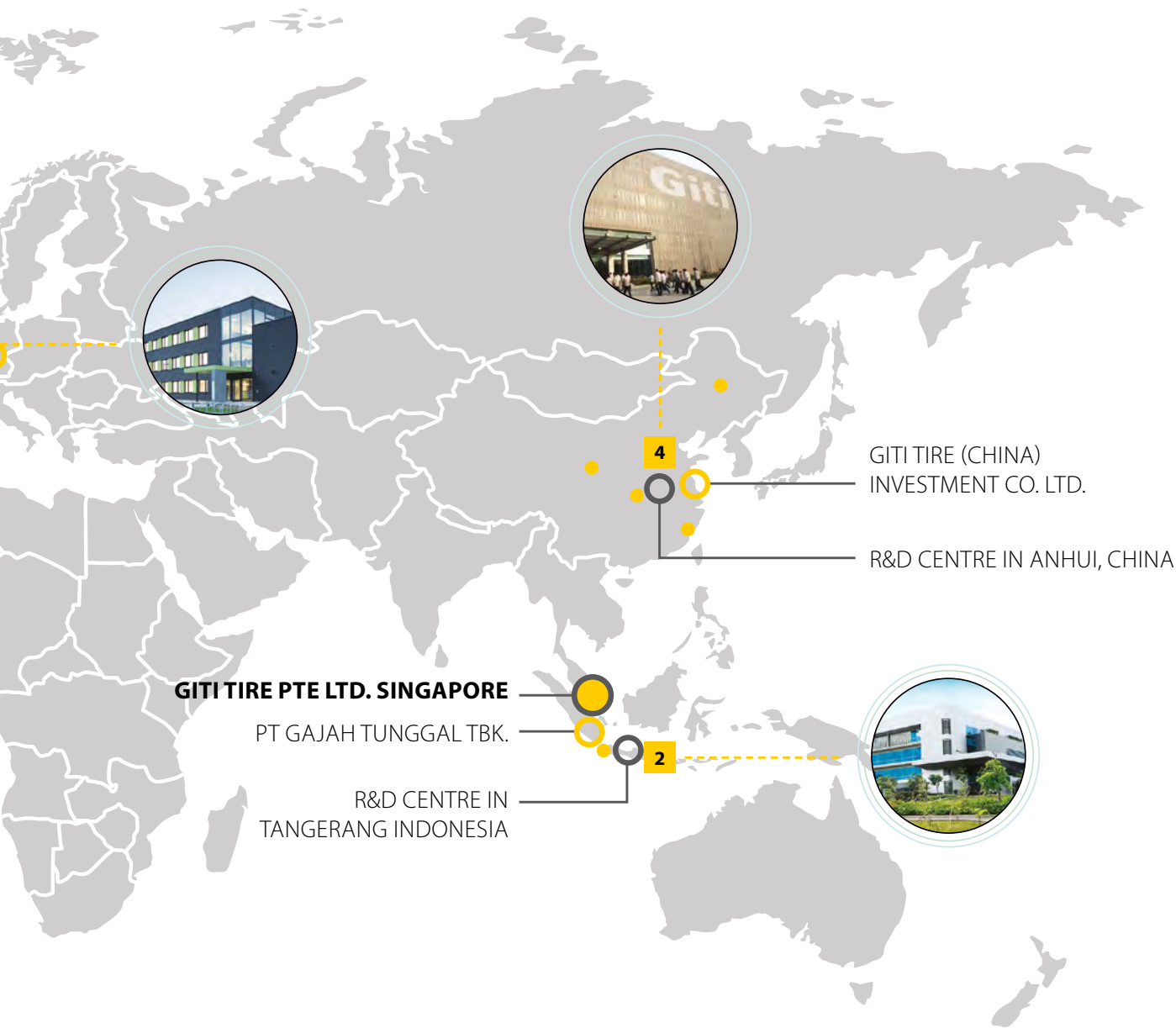

- Headquarters
- Overseas Office
- Global R&D Centre
- Manufacturing Plant



CUTTING-EDGE R&D CAPABILITIES

- | | | | |
|--|----------------------|--|-----------------------|
| 1  | R&D CENTRE EUROPE | 4  | R&D CENTRE CHINA |
| 2  | R&D CENTRE INDONESIA | 5  | EUROPE TESTING CENTRE |
| 3  | R&D CENTRE USA | | |

WORLD CLASS MANUFACTURING FACILITIES

WHEN YOU PUT A SET OF GITI TIRES ON YOUR VEHICLE, YOU CAN BE CONFIDENT THAT YOUR TIRES HAVE BEEN PUT THROUGH ONE OF THE MOST RIGOROUS AND COMPREHENSIVE QUALITY CONTROL SYSTEMS IN THE INDUSTRY.

- > Manufacturing in 3 Countries, one truly global tire company
- > Five Giti tire plants have an annual capacity of well over 111,000,000 tires
- > All plants have obtained IATF 16949 accreditation (highest standard of quality control) and ISO 14001 Environmental Management System Accreditation
- > Very strict quality controls and inspections at each stage of the production process ensure that each component meets the relevant specifications and standards

INTERNATIONALLY ACCEPTED PRODUCT QUALITY AND ACCREDITATION



RDW



GITI COMPETITION TRUCK RACING













GITI TIRE HAS RAISED ITS TOP LEVEL RACING CAPABILITIES TO INCLUDE TRUCKS. COMPETING ON SOME OF THE TOUGHEST TRACKS THROUGHOUT EUROPE, RACING ALSO PROVIDES A CHANCE FOR EXTREME TESTING AND ANALYSIS OF ITS SPECIALTY TRUCK COMPETITION TIRE, WHICH IS ALSO USED TO MAXIMISE THE PERFORMANCE OF GITI'S OTHER TBR OFFERINGS.



**GitiCompete
RACE-TUNED V1**



PRODUCT APPLICATION OVERVIEW

	COMBI ROAD								ECO ROAD	LONG HAUL			
													
	GSR225	GSR236	GSR237	GSR259	GDR675	GDR655+ GDR655	GDR665+ GDR665	GTR955	GDL617 ECO	GAL817	GDL617	GTL919+ GTL919	GTL925
Size/Position	Steer				Drive			Trailer	Drive	Steer	Drive	Trailer	
Page in Cat.	22	18	20	24	26	28	30	32	36	40	42	44	46
245/70R17.5		136/134 M						143/141 (146/146) K (F)				143/141 (146/146) J (F)	
205/75R17.5		124/122 M											
215/75R17.5		128/126 M						136/134 K				136/134 J	
225/75R17.5		129/127 M											
235/75R17.5		132/130 M						143/141 (146/146) K (F)				143/141 (146/146) J (F)	
9.5R17.5													
245/70R19.5	136/134 M											141/140 J	
265/70R19.5	140/138 M											143/141 J	
285/70R19.5	146/145 M											150/148 J	
435/50R19.5													164 J
445/45R19.5													164 J
10.00R20													
11.00R20													
12.00R20													
14.00R20													
9R22.5										136/134 M			
10R22.5										144/142 M			
11R22.5	148/145 M		149/146 M			148/145 M							
12R22.5			152/149 M										
13R22.5													
255/70R22.5										140/137 M			
275/70R22.5			148/145 (152/148) M (J)										
295/80R22.5	154/149 M		154/149 M		152/149 M	152/149 M	152/149 M					152/148 M	
295/60R22.5			150/147 L		150/147 (149/146) K (L)							150/147 (149/146) K (L)	
305/70R22.5													
315/80R22.5	158/150 (154/150) L (M)		158/150 (154/150) L (M)		156/150 (154/150) L (M)	156/150 (154/150) L (M)	156/150 (154/150) L (M)					156/150 (154/150) L (M)	
315/70R22.5	156/150 (154/150) L (M)		156/150 (154/150) L (M)		154/150 (152/148) L (M)	154/150 (152/148) L (M)			154/150 (152/148) L (M)			154/150 (152/148) L (M)	
315/60R22.5			156/150 L		152/148 L							152/148 L	
355/50R22.5			156 L										
385/55R22.5								164 (158) K (L)				160 (158) K (L)	
385/65R22.5				164 (160) K (L)				164 (158) K (L)				164 (158) K (L)	
425/65R22.5												165 K	
445/65R22.5													
12.00R24													
325/95R24													

	REGIONAL		MIXED SERVICE & ON/OFF				URBAN			WINTER	
	GAR820	GDR638	GAM831	GAM837	GAM851	GDM686 GDM686+	GAU861	GT867	GAU867 ¹⁾	GSW226	GDR621+
Size/Position	All positions	Drive	All positions			Drive	All positions			Steer Trailer	Drive
Page in Cat.	50	52	56	58	62	60	66	68	70	74	76
245/70R17.5	136/134 M	136/134 M									
205/75R17.5	124/122 M	124/122 M									
215/75R17.5	128/126 M	126/124 M							128/126 M		
225/75R17.5	129/127 M	129/127 M									
235/75R17.5	132/130 M	132/130 M									
9.5R17.5	143/141 K										
245/70R19.5		136/134 M						136/134 M			
265/70R19.5		140/138 M							143/141 J		
285/70R19.5		146/145 M									
435/50R19.5											
445/45R19.5											
10.00R20											
11.00R20											
12.00R20											
14.00R20											
9R22.5											
10R22.5											
11R22.5						148/145 J		148/145 J	148/145 J		
12R22.5						152/148 K					
13R22.5			156/150 (154/150) K (L)			156/150 K					
255/70R22.5											
275/70R22.5							152/148 (150/148) J(K)		152/148 (150/148) J (K)		
295/80R22.5			154/149 (152/149) K (L)			152/149 K			154/150 J		
295/60R22.5											
305/70R22.5								152/150 (154/150) J (E)			
315/80R22.5			158/150 (154/150) K (L)			158/150 K		158/150 J		158/150 (154/150) L (M)	158/150 (154/150) L (M)
315/70R22.5				156/150 (154/150) L (M)						156/150 (154/150) L (M)	154/150 (152/148) L (M)
315/60R22.5											
385/55R22.5										158 (160) L (J)	
385/65R22.5					164 (158) K (L)					164 (160) K (L)	
425/65R22.5					165 K						
445/65R22.5					169 K						
12.00R24											
325/95R24											

COMBI ROAD



THE COMBI ROAD SEGMENT REPRESENTS A BROAD RANGE OF QUALITY PRODUCTS DESIGNED TO OPTIMISE FLEET OPERATIONS IN BOTH LONG HAUL AND REGIONAL ROUTES. FOCUSED ON FUEL SAVING AND HIGH MILEAGE, COMBI ROAD OFFERS THE FULL RANGE OF FRONT, DRIVE AND TRAILER AXLE TIRES WITH SUPERIOR PERFORMANCE CERTIFIED AND PROVED BY EUROPEAN FLEET PARTNERS. DEVELOPED IN STRONG CO-OPERATION WITH THE GITI EUROPEAN R&D CENTRE IN GERMANY, COMBI ROAD PRODUCTS REPRESENT A SUSTAINABLE SOLUTION FOR A RELIABLE AND MODERN BUSINESS.



Product Offer

COMBI ROAD

GSR236

COMBI ROAD



SMALL SIZE SEGMENT STEER TIRE FOR BOTH
HIGHWAY AND REGIONAL APPLICATION

> Robust construction and high mileage tread compound with focus on regional and urban application

> High level of wet braking performance with low noise

> 3PMSF Certified



3 Grooves tread design to enhance the pattern stiffness and extend the mileage range. Wide shoulder ribs to prevent irregular wear and improve cornering stability.

Deep transversal sipes to improve grip and traction in wet and ice/snow conditions. High level of safety and driving stability in every kind of usage conditions.

Extremely wide shoulder ribs for robust tire reaction in case of tough usage conditions. Wide shoulders provide, at the same time, excellent protection to shoulder wear phenomena.

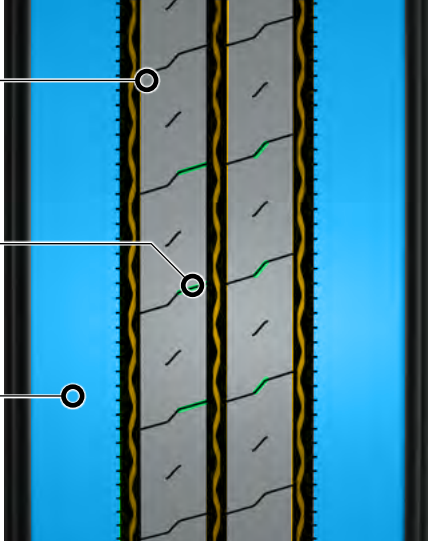

Size	LI	SI	Pattern		Rim	Load Single Kg	Load Dual Kg			Noise dB			
205/75R17.5	124/122	M	GSR236	3PMSF	6.00	1600	1500	205	753	67	A	B	D
215/75R17.5	128/126	M	GSR236	3PMSF	6.00	1800	1700	211	767	67	A	B	D
225/75R17.5	129/127	M	GSR236	3PMSF	6.75	1850	1750	226	783	69	A	B	C
235/75R17.5	132/130	M	GSR236	3PMSF	6.75	2000	1900	233	797	69	A	B	C
245/70R17.5	136/134	M	GSR236	3PMSF	7.50	2240	2120	248	789	69	A	B	D

Key Performance

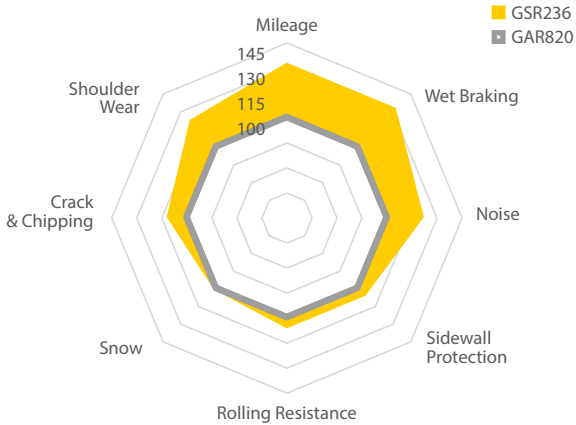

Field test in Europe

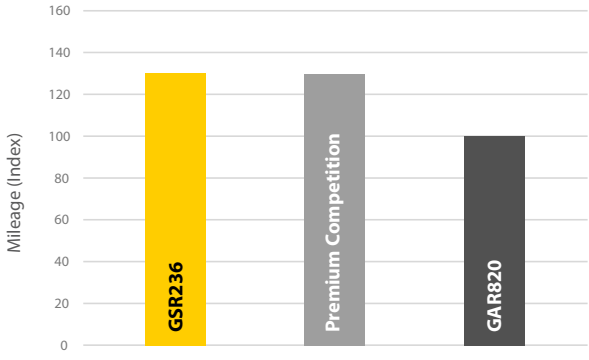

Internal test (2021) in size 215/75R17.5 in fleets in United Kingdom

GSR237

COMBI ROAD



LATEST STEER TIRE FOR BOTH HIGHWAY
AND REGIONAL APPLICATION

> Pattern design for outstanding mileage performances and top label ranking for the segment

> Size 355/50R22.5 for high load and low platform transportation

> 3PMSF Certified







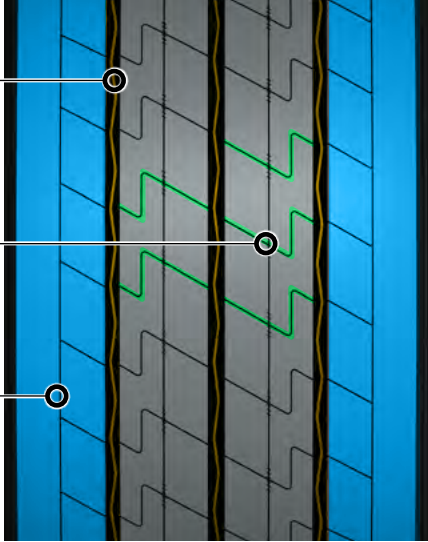

Extremely wide and robust tread design with 3 or 4 main grooves to limit the tread elements movement and increase the pattern stiffness.

Straight longitudinal grooves for effective water evacuation and deep transversal sipes to improve grip and traction on snow and ice in case of winter conditions.

Very robust shoulders for a controlled abrasion, excellent driving feeling and silent journey. GSR237 pattern shows even abrasion and no phenomena of irregular wear.



Size	LI	SI	Pattern		Rim	Load Single Kg	Load Dual Kg			Noise dB			
355/50R22.5	156	L	GSR237	3PMSF	11.75	4000	0	361	928	70	A	B	B
3 grooves pattern													
11R22.5	149/146	M	GSR237	3PMSF	8.25	3250	3000	279	1054	70	A	B	C
12R22.5	152/149	M	GSR237	3PMSF	9.00	3550	3250	300	1085	70	A	B	C
275/70R22.5	148/145 (152/148)	M (J)	GSR237	3PMSF	8.25	3150	2900	276	958	69	A	B	C
295/60R22.5	150/147	L	GSR237	3PMSF	9.00	3350	3075	292	926	70	A	B	D
295/80R22.5	154/149	M	GSR237	3PMSF	9.00	3750	3250	298	1044	70	A	B	C
315/60R22.5	156/150	L	GSR237	3PMSF	9.75	3750	3150	313	950	71	A	B	C
315/70R22.5	156/150 (154/150)	L (M)	GSR237	3PMSF	9.00	4000	3350	312	1014	70	A	B	C
315/80R22.5	158/150 (154/150)	L (M)	GSR237	3PMSF	9.00	4250	3350	312	1076	70	A	B	C

4 grooves pattern

Field test in Europe

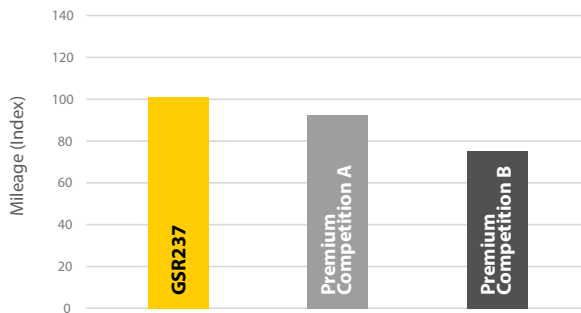

Internal test (2021) in size 355/50R22.5 in fleets in Italy and Germany

GSR225

COMBI ROAD



GSR225 COMBI ROAD IS A HIGH-PERFORMANCE STEER AND TRAILER TIRE FOR NATIONAL AND REGIONAL OPERATIONS

> New tread and base compounds provide exceptional mileage performance and regular wear

> Increased load capacity to cater for higher axle loads on Euro 6 vehicles

> Excellent wet and dry handling properties

> 3PMSF Certified







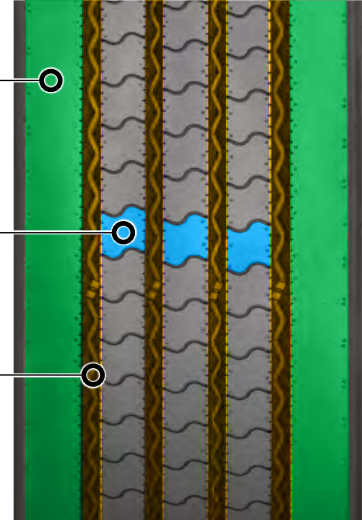

Wide and robust shoulder ribs with superior cornering stability and improved vehicle handling.

Latest developed tread compound with enhanced mileage and improved tear resistance.

Diamond groove shape for better stone ejection and improved tearing and cracking protection.



Size	LI	SI	Pattern		Rim	Load Single Kg	Load Dual Kg			Noise dB			
245/70R19.5	136/134	M	GSR225	3PMSF	7.50	2240	2120	248	839	71	A	C	C
265/70R19.5	140/138	M	GSR225	3PMSF	7.50	2500	2360	262	867	71	A	C	D
285/70R19.5	146/145	M	GSR225	3PMSF	8.25	3000	2900	283	895	71	A	C	C
11R22.5	148/145	M	GSR225	3PMSF	8.25	3150	2900	279	1054	71	A	C	D
295/80R22.5	154/149	M	GSR225	3PMSF	9.00	3750	3250	298	1053	72	B	B	D
315/70R22.5	156/150 (154/150)	L (M)	GSR225	3PMSF	9.00	4000	3350	312	1014	71	A	B	C
315/80R22.5	158/150 (154/150)	L (M)	GSR225	3PMSF	9.00	4250	3350	312	1076	71	A	B	C

GSR259

COMBI ROAD



WIDE BASE STEER AXLE TIRE FOR LONG
AND REGIONAL HAULAGE

> Specially designed compound allowing cooler running, reduced fuel consumption, increased resistance to irregular wear, with excellent transverse and longitudinal grip

> Wide base technology with optimised footprint

> 3PMSF Certified







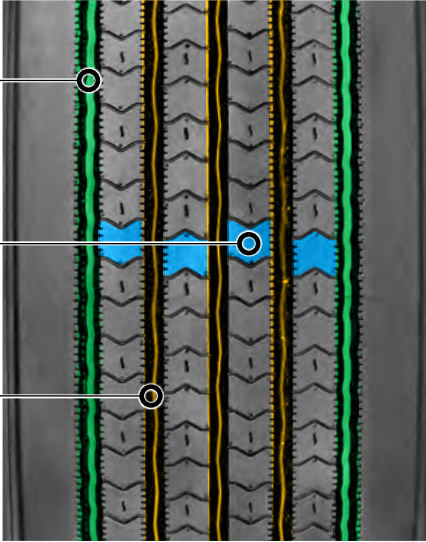

Wider shoulder grooves for a superior lateral stability on aggressive regional routes.

New generation tread compound with low heat generation and low fuel consumption.

Deep and straight central grooves to evacuate water and improve driving stability in long haul usage.



Size	LI	SI	Pattern		Rim	Load Single Kg	Load Dual Kg			Noise dB			
385/55R22.5	158 (160)	L (K)	GSR259	3PMSF	12.25	4250		386	996	70	A	B	C
385/65R22.5	164 (160)	K (L)	GSR259	3PMSF	11.75	5000		389	1072	70	A	B	C



GDR675

COMBI ROAD



THE LATEST GENERATION COMBI ROAD DRIVE AXLE TIRE, DESIGNED AND DEVELOPED TO PROVIDE CLASS-LEADING PERFORMANCE

> Innovative directional tread pattern design with 3D sipes technology for enhanced mileage, superior traction and low rolling noise

> Improved tire durability and retreadability thanks to robust and enhanced carcass construction



Interconnected, big central rubber blocks and 3D sipes technology create a synergistic effect to enhance tread stiffness and control deformation, providing outstanding mileage.

Variable tie-bar dimension solution reduces tire rolling noise and optimises stiffness and tread robustness for a safe and comfortable journey.

Narrow central circumferential grooves embedded with stone ejector elements for excellent driving properties and higher protection for the casing.

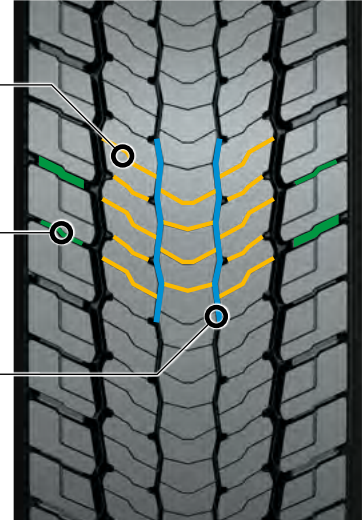

Size	LI	SI	Pattern		Rim	Load Single Kg	Load Dual Kg			Noise dB			
295/60R22.5	150/147 (149/146)	K (L)	GDR675	3PMSF	9.00	3350	3075	292	932	*	*	*	*
295/80R22.5	152/149	M	GDR675	3PMSF	9.00	3550	3250	298	1050	71	A	B	D
315/60R22.5	152/148	L	GDR675	3PMSF	9.00	3550	3150	313	950	71	A	B	D
315/70R22.5	154/150 (152/148)	L (M)	GDR675	3PMSF	9.00	3750	3350	312	1014	71	A	B	D
315/80R22.5	156/150 (154/150)	L (M)	GDR675	3PMSF	9.00	4000	3350	312	1076	71	A	B	D

* To be announced

Key Performance

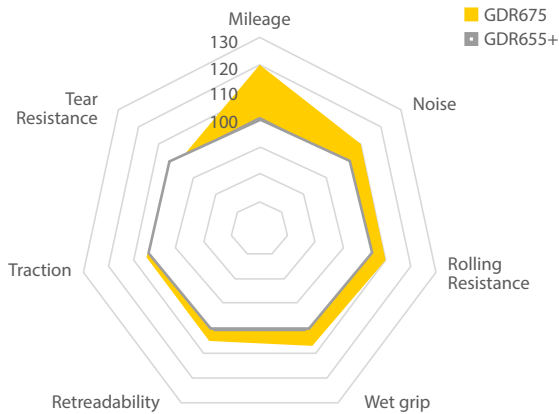

Field test in Europe

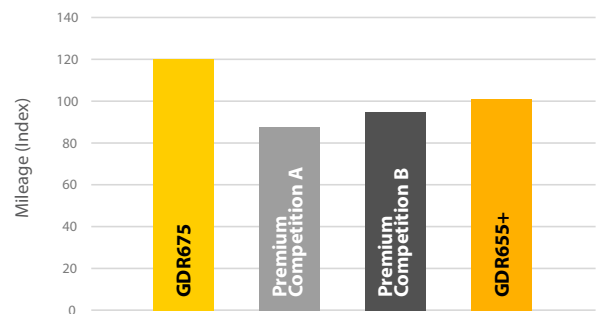

Internal field test (2020) in size 315/70R22.5 carried out in UK

GDR655 GDR655+

COMBI ROAD



A MODERN COMBI ROAD NON-DIRECTIONAL
DRIVE AXLE PATTERN EMBEDDED WITH NEW
TECHNOLOGY

> Plus "+" version for significant
mileage increase compared
to GDR655

> Low fuel consumption (label
upgrade for 315/80R22.5 GDR655+)



Plus "+" on sidewall stay for "latest Giti Technology Tread compound" for Combi Road application: +30% mileage improvement vs. previous GDR655 confirmed in dedicated fleet tests in the European market.

Low heat generation tread compound for lower tire rolling resistance and better casing durability.

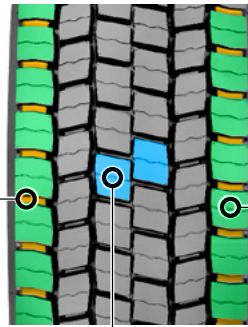

Optimised tread block shape geometry for enhanced traction properties and even pressure distribution in the tire footprint.

High tie bar in the shoulder area improves pattern stiffness and shoulder robustness.

Non-directional drive tire to simplify fleet tire maintenance. Very wide tread with 6-rib pattern design for the best driving sensation.

Size	LI	SI	Pattern		Rim	Load Single Kg	Load Dual Kg			Noise (dB)			
315/70R22.5	154/150 (152/148)	L (M)	GDR655+	3PMSF	9.00	3750	3350	312	1014	74	B	C	D
315/80R22.5	156/150 (154/150)	L (M)	GDR655+	3PMSF	9.00	4000	3350	312	1076	74	B	C	D
11R22.5	148/145	M	GDR655	3PMSF	8.25	3150	2900	279	1054	74	B	C	E
295/80R22.5	152/149	M	GDR655	3PMSF	9.00	3550	3250	298	1044	74	B	C	D
315/70R22.5	154/150 (152/148)	L (M)	GDR655	3PMSF	9.00	3750	3350	312	1014	76	B	B	D

Key Performance

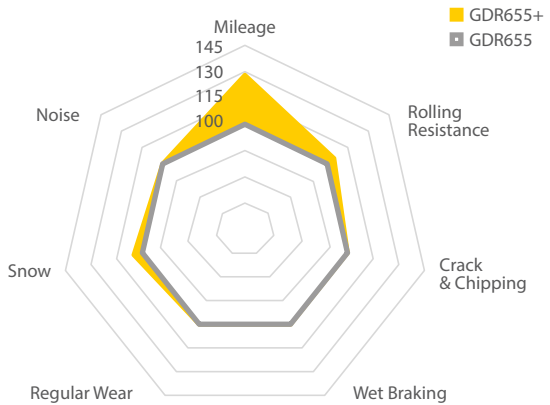

Field test in Europe

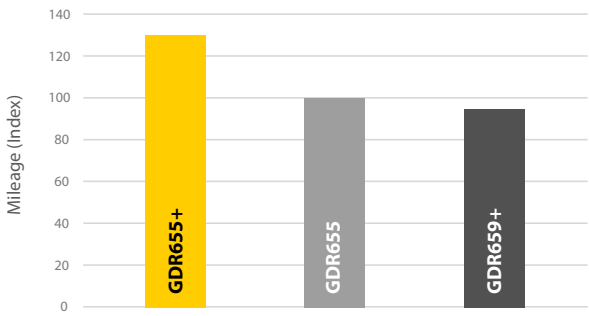

GDR665 GDR665+

COMBI ROAD



A MODERN GITI COMBI ROAD DRIVE AXLE PATTERN
EMBEDDED WITH NEW TECHNOLOGY

> Directional drive axle tread design concept – enhancing both traction and braking

> Plus “+” version for significant mileage increase compared to GDR665

> Regular wear combined with excellent traction in both dry, wet and winter conditions

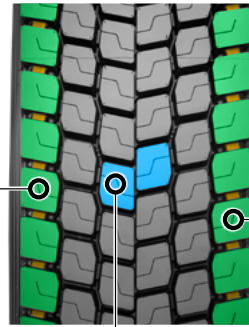

Plus "+" on sidewall stay for "latest Giti Technology Tread compound" for Combi Road application: +30% mileage improvement vs. previous GDR665 confirmed in dedicated fleet tests in the European market.

Low heat generation tread compound for lower tire rolling resistance and better casing durability.

Optimised tread block shape geometry for enhanced traction properties and even pressure distribution in the tire footprint.

High tie bar in the shoulder area improves pattern stiffness and shoulder robustness.

Directional drive tire to ensure excellent traction. Very wide tread with 6-rib pattern design for the best driving sensation.

Size	LI	SI	Pattern		Rim	Load Single Kg	Load Dual Kg			Noise (dB)			
295/80R22.5	152/149	M	GDR665+	3PMSF	9.00	3550	3250	298	1050	76	B	C	D
295/80R22.5	152/149	M	GDR665	3PMSF	9.00	3550	3250	298	1044	76	B	C	D
315/80R22.5	156/150 (154/150)	L (M)	GDR665	3PMSF	9.00	4000	3350	312	1076	76	B	B	D

GTR955

COMBI ROAD



THE LATEST GITI COMBI ROAD TRAILER AXLE
PATTERN, EMBEDDED WITH NEW TECHNOLOGY

> GTR955 is the optimum Giti Trailer tire for usage in Combi Road conditions

> Combines high load capacity with high mileage, low noise and low fuel consumption

> 3PMSF Certified







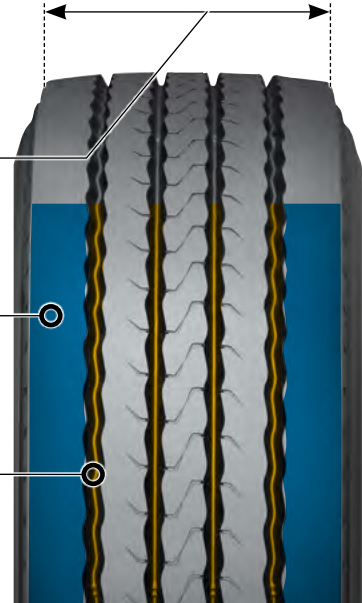

Wide tread width, optimised footprint, and the latest generation tread compound for even pressure distribution, low abrasion rate, and much longer mileage.

Extra-wide and robust shoulder ribs deliver exceptional regular wear.

The new circumferential groove design reduces grit trapping, improves engagement, and ensures water drainage at all stages of wear.



Size	LI	SI	Pattern		Rim	Load Single Kg	Load Dual Kg			Noise dB			
215/75R17.5	136/134	K	GTR955	3PMSF	6.00	2180	2060	212	767	66	A	B	C
235/75R17.5	143/141 (146/146)	K (F)	GTR955	3PMSF	6.75	2725	2575	233	797	67	A	B	C
245/70R17.5	143/141 (146/146)	K (F)	GTR955	3PMSF	7.50	2725	2575	248	789	67	A	B	C
385/55R22.5	164 (158)	K (L)	GTR955	3PMSF	12.25	4250		386	996	69	A	B	B
385/65R22.5	164 (158)	K (L)	GTR955	3PMSF	11.75	5000		389	1072	71	A	B	B

Key Performance

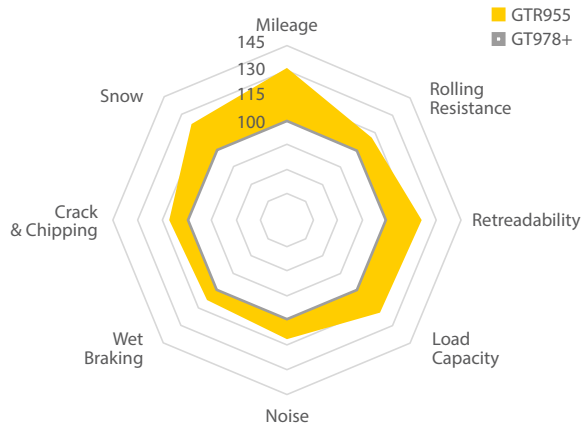

Field test in Europe

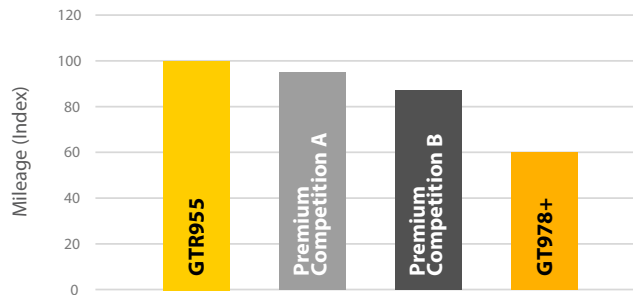

Internal test (2018) in size 385/65R22.5 in fleets in Belgium and the Netherlands

ECO ROAD



MINIMIZE THE CO₂ FOOTPRINT AND REDUCE THE VEHICLES ENERGY CONSUMPTION; THAT IS THE MISSION OF THE NEW ECO ROAD PRODUCT SEGMENT, DEVELOPED IN THE GITI STATE-OF-THE-ART R&D FACILITIES AND FOCUSED ON PURE HIGHWAY TRANSPORT USAGE. INNOVATION IN MATERIALS, AND TECHNOLOGICALLY ADVANCED TREAD AND CASING DESIGNS ARE THE KEY ELEMENTS OF THE SUCCESS OF THE BRAND-NEW SEGMENT; OFFERING THE PRODUCT “BEST IN CLASS” IN ROLLING RESISTANCE, AND KEEPING THE HIGH QUALITY AND WELL-KNOWN ENDURANCE CHARACTERISTICS OF GITI TRUCK AND BUS TIRE PRODUCTS. GITI’S ECO ROAD SEGMENT OFFERS THE PERFECT SOLUTION FOR SUSTAINABLE, ECO-FRIENDLY TRANSPORT MOBILITY.



Product Offer

ECO ROAD

GDL617 ECO

ECO ROAD



DRIVE LONG HAUL TIRE WITH LOW ROLLING RESISTANCE FOR A SUSTAINABLE JOURNEY

> B class in rolling resistance to reduce fuel consumption

> Consolidated pattern design for superior mileage

> 3PMSF Certified







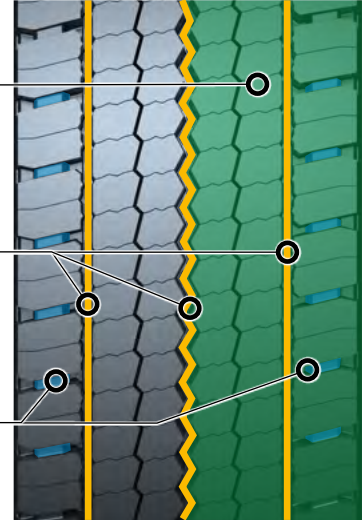

Ecoroad product features a consolidated Giti pattern technology combined with a new and innovative tread compound with lower hysteresis generation and low rolling resistance.

One main zig-zag center groove in combination with two laterals for effective water evacuation and high level of traction in every road condition. Stone ejectors elements to prevent the bottom groove from casing damage.

Shoulder blocks connected with robust tie-bar to enhance the pattern stiffness. Low noise and controlled abrasion for a safe and comfortable journey.



Size	LI	SI	Pattern		Rim	Load Single Kg	Load Dual Kg			Noise dB			
315/70R22.5	154/150 (152/148)	L (M)	GDL617 ECO	3PMSF	9.00	3750	3350	312	1014	74	B	C	B

Key Performance

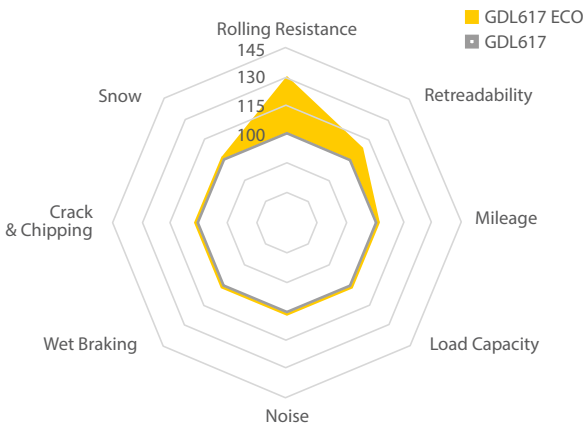

LONG HAUL



SELECTED PRODUCTS FOR TRUCKS AND BUSES WITH TECHNOLOGIES TO MAXIMISE TIRE PERFORMANCE WHEN USED IN HIGHWAY OPERATION. A PERFECT SYNERGY OF LOW-HEAT-GENERATION-MATERIALS AND ADVANCED STRUCTURES PROVIDES AN INNOVATIVE AND SUSTAINABLE TIRE WITH EXTENDED MILEAGE, LOW NOISE GENERATION, AND A VERY REGULAR ABRASION PROFILE. LIGHT AND SOLID COMPONENTS, COMBINED WITH SPECIFIC TREAD DESIGN, RESULT IN AN EXCELLENT TIRE FOR LONG DISTANCE JOURNEYS.





Product Offer

LONG HAUL

GAL817

LONG HAUL



STEER TIRE FOR USE ON MEDIUM HEAVY VEHICLES
IN LONG HAUL AND REGIONAL APPLICATIONS

> High-speed steer tires for use in long haul and regional operations on medium heavy trucks

> Modern tread design offers very comfortable driving combined with good mileage performance



FEATURES		BENEFITS
	Wide footprint with a wide shoulder design	Provides very regular wear pattern and excellent handling
	Redesigned casing construction	Provides an optimised road surface footprint for regular wear and improved mileage
	Low noise level	Silent and comfortable drive

Size	LI	SI	Pattern		Rim	Load Single Kg	Load Dual Kg			Noise dB			
9R22.5	136/134	M	GAL817		6.75	2240	2120	229	974	70	A	C	E
10R22.5	144/142	M	GAL817		7.50	2800	2650	254	1019	70	A	C	D

GDL617

LONG HAUL





LONG HAUL TIRE FOR HIGH MILEAGE IN DRIVE
AXLE POSITIONS





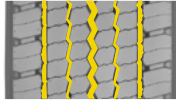

> A compact non-directional tread design with multi sipe arrangement, it has the latest cool running compound technology

> Extended mileage performance and regular wear, combined with excellent traction in dry, wet and winter conditions

> 3PMSF Certified



FEATURES		BENEFITS
	Wide tread pattern design	Increases mileage, traction and driver comfort through high level of stability
	Optimal tread depth for long haul applications	Reduces fuel consumption while delivering excellent mileage
	Non-directional pattern	Simplification of tire maintenance in fleets

Size	LI	SI	Pattern		Rim	Load Single Kg	Load Dual Kg			Noise dB			
295/60R22.5	150/147 (149/146)	K (L)	GDL617	3PMSF	9.00	3350	3075	292	932	74	B	C	D
295/80R22.5	152/148	M	GDL617	3PMSF	9.00	3550	3150	298	1044	74	B	C	C
315/60R22.5	152/148	L	GDL617	3PMSF	9.75	3550	3150	313	950	74	B	B	D
315/70R22.5	154/150 (152/148)	L (M)	GDL617	3PMSF	9.00	3750	3350	312	1014	74	B	C	D
315/80R22.5	156/150 (154/150)	L (M)	GDL617	3PMSF	9.00	4000	3350	312	1076	74	B	C	D

GTL919 GTL919+

LONG HAUL



TRAILER PATTERN FOR LONG AND REGIONAL
HAULAGE

> Optimum tread depth for improved wear-out rate

> Extra-wide shoulder rib for improved mileage performance and even, regular wear

> 3PMSF Certified



FEATURES		BENEFITS
	New generation pattern featuring a new groove design and extra-wide shoulder	Provides good protection in the shoulder area and very regular wear
	Dedicated compound formula for long distance use	Reduces fuel consumption while providing high mileage
	New casing construction	Improves casing stiffness and footprint, resulting in longer tire life
	Additional upper sidewall protection	Improves protection against curb damage

Size	LI	SI	Pattern		Rim	Load Single Kg	Load Dual Kg			Noise dB			
385/65R22.5	164 (158)	K (L)	GTL919+	3PMSF	11.75	5000		389	1072	69	A	B	B
215/75R17.5	136/134	J	GTL919	3PMSF	6.00	2240	2120	212	767	69	A	C	D
235/75R17.5	143/141 (146/146)	J (F)	GTL919	3PMSF	6.75	2725	2575	233	797	69	A	C	C
245/70R17.5	143/141 (146/146)	J (F)	GTL919	3PMSF	7.50	2725	2575	248	789	69	A	C	C
245/70R19.5	141/140	J	GTL919	3PMSF	7.50	2575	2500	248	839	69	A	C	C
265/70R19.5	143/141	J	GTL919	3PMSF	7.50	2725	2575	262	867	69	A	C	C
285/70R19.5	150/148	J	GTL919	3PMSF	8.25	3350	3150	283	895	69	A	C	C
385/55R22.5	160 (158)	K (L)	GTL919	3PMSF	12.25	4500		386	996	71	A	B	C
425/65R22.5	165	K	GTL919	3PMSF	12.25	5150		422	1124	69	A	B	C

GTL925

LONG HAUL





LOW PLATFORM TRAILER PATTERN DEVELOPED FOR
MODERN 3-METER INSIDE HEIGHT MEGATRAILERS
ABLE TO BE USED ON 10-TON AXLES





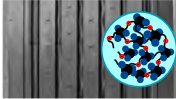

> Wide, low-profile casing and tread design, provides high mileage potential, low rolling resistance with reduced noise levels

> Extra-wide shoulder designed for enhanced resistance to tearing, improved mileage performance, and increased regular wear

> 3PMSF Certified



FEATURES		BENEFITS
 ROBUST CASING	Latest high-technology casing design for usage on 10-ton axles	Very high casing stiffness coupled with optimal footprint, resulting in safe handling, braking and longer tire life
	Wide shoulders with wear-stabilising outer groove features	Protects casing from impact damage in the shoulder area
	Low diameter tire	Designed for high cube trailers for long and regional use
	New, highly reinforced tread compound with enhanced abrasion resistance	High mileage combined with a reduction in overall fuel consumption and casing fatigue

Size	LI	SI	Pattern		Rim	Load Single Kg	Load Dual Kg			Noise dB			
435/50R19.5	164	J	GTL925	3PMSF	14.00	5000		438	931	69	A	D	C
445/45R19.5	164	J	GTL925	3PMSF	14.00	5000		436	895	69	A	C	B

REGIONAL



CONSOLIDATED TECHNICAL SOLUTIONS FOR TIRES USED MAINLY ON REGIONAL ROUTES WITH ROBUST CONSTRUCTION AND HIGHLY REINFORCED TREAD COMPOUNDS TO PROVIDE OUTSTANDING MILEAGE EVEN IN EXTREMELY SEVERE OPERATING CONDITIONS. TRACTION, SAFETY, AND TIRE DURABILITY ARE GUARANTEED IN EVERY FLEET IN ALL DRIVING CONDITIONS; BESIDES HIGH COMFORT, LOW NOISE AND EXCELLENT WET AND WINTER PROPERTIES HAVE BEEN WIDELY PROVED IN MANY EUROPEAN COUNTRIES – FROM THE SOUTHERN TO NORDIC REGIONS.





Product Offer

REGIONAL

GAR820

REGIONAL

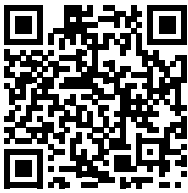







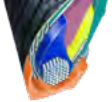

REGIONAL HAUL PATTERN SUITABLE FOR ALL AXLE POSITIONS ON MEDIUM HEAVY VEHICLES

> Created in response to the fast development of modern, medium-sized truck requirements

> GAR820 offers modern vehicles a high level of comfort, low noise, good wet, dry and winter properties, in addition to excellent wear performance



FEATURES	BENEFITS
 <p>New pattern design concept with wide, solid shoulders</p>	Improves handling and driver comfort, in addition to reducing noise levels
 <p>Block-design in the centre of the tread</p>	Increased traction and braking in loaded and unloaded driving conditions
 <p>New casing construction and optimised footprint design</p>	Regular wear throughout the life of the tire, delivering excellent mileage performance
 <p>Latest bead construction</p>	Facilitates mounting the tire and improves uniformity

Size	LI	SI	Pattern		Rim	Load Single Kg	Load Dual Kg			Noise dB			
9.5R17.5	143/141	K	GAR820	3PMSF	6.75	2725	2575	240	842	74	B	C	E
205/75R17.5	124/122	M	GAR820	3PMSF	6.00	1600	1500	205	753	71	A	D	D
215/75R17.5	128/126	M	GAR820	3PMSF	6.00	1800	1700	211	767	71	A	D	D
225/75R17.5	129/127	M	GAR820	3PMSF	6.75	1850	1750	226	783	71	A	D	D
235/75R17.5	132/130	M	GAR820	3PMSF	6.75	2000	1900	233	797	71	A	C	D
245/70R17.5	136/134	M	GAR820	3PMSF	7.50	2240	2120	248	789	74	B	C	D

GDR638

REGIONAL









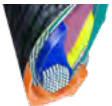

NEW, REGIONAL DRIVE AXLE TIRE FOR LIGHT AND MEDIUM HEAVY TRUCKS AND BUSES USING 17.5 AND 19.5 INCH TIRES

> GDR638 meets the increasing demands of the medium-sized truck operator, providing comfort, low noise, good wet and dry handling, in addition to excellent mileage performance

> Excellent all-season and medium-severe winter properties



FEATURES	BENEFITS
 <p>Pattern design with small blocks and 4 longitudinal grooves</p>	Provides good traction and braking, with improved vehicle stability and driver comfort
 <p>New casing construction</p>	Improves casing stiffness and footprint, resulting in longer tire life
 <p>Incorporates the latest bead construction</p>	Improved uniformity and makes fitting to the rim easier

Size	LI	SI	Pattern		Rim	Load Single Kg	Load Dual Kg			Noise dB			
205/75R17.5	124/122	M	GDR638	3PMSF	6.00	1600	1500	205	753	74	B	C	D
215/75R17.5	126/124	M	GDR638	3PMSF	6.00	1700	1600	211	767	74	B	C	E
225/75R17.5	129/127	M	GDR638	3PMSF	6.75	1850	1750	226	783	74	B	C	D
235/75R17.5	132/130	M	GDR638	3PMSF	6.75	2000	1900	233	797	74	B	C	D
245/70R17.5	136/134	M	GDR638	3PMSF	7.50	2240	2120	248	789	74	B	C	D
245/70R19.5	136/134	M	GDR638	3PMSF	7.50	2240	2120	248	839	75	B	C	D
265/70R19.5	140/138	M	GDR638	3PMSF	7.50	2500	2360	262	867	75	B	C	D
285/70R19.5	146/145	M	GDR638	3PMSF	8.25	3000	2900	283	895	75	B	B	D

MIXED SERVICE & ON/OFF



TIRES DESIGNED TO MOVE FORWARD AND CLIMB OVER EVERY OBSTACLE IN THE ROUGHEST WORKING TERRAINS THANKS TO SPECIFIC AND ROBUST TECHNICAL SOLUTIONS IN BOTH THE CASING AND TREAD AREAS. THE MIXED SERVICE SEGMENT OFFERS A COMPLETE RANGE OF FRONT, DRIVE, AND TRAILER TIRES DEVELOPED TO ALLOW FLEETS TO WORK WITHOUT RESTRICTIONS AT TOUGH WORK SITES AND ACHIEVE VERY HIGH MILEAGE WHEN USED ON ASPHALT ROADS. ENHANCED MATERIALS ARE USED IN COMBINATION WITH STATE-OF-THE-ART TIRE DESIGNS TO OFFER A RELIABLE SOLUTION FOR HEAVY OPERATIONS.





Product Offer

MIXED SERVICE & ON/OFF

GAM831

MIXED SERVICE



AN ALL-AXLE POSITION TIRE DESIGNED FOR
VARIED ON/OFF-ROAD OPERATIONS

> A combination of rib and lug design with enhanced tread profile gives good self-cleaning properties

> The anti-cut-and-chip compound provides excellent protection against damage from impacts, cuts and abrasions

> 3PMSF Certified



FEATURES		BENEFITS
	New casing construction with optimised tread profile	Provides an optimal footprint for improved wear and vehicle handling
	Special groove design	Prevents groove stone trapping, protecting the tire from road hazards
	Solid, wide shoulder ribs	Improves protection of the casing while improving stability and comfort for the driver
	New, advanced anti-cut-and-chip compound	High resistance against tread tearing from normal use on aggressive road surfaces

Size	LI	SI	Pattern		Rim	Load Single Kg	Load Dual Kg			Noise dB			
13R22.5	156/150 (154/150)	K (L)	GAM831	3PMSF	9.75	4000	3350	320	1124	74	B	B	D
315/80R22.5	158/150 (154/150)	K (L)	GAM831	3PMSF	9.00	4250	3350	312	1076	73	A	B	D

GAM837

MIXED SERVICE





AN ALL-AXLE POSITION TIRE DESIGNED FOR
VARIED ON/OFF-ROAD OPERATIONS





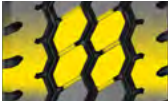

> A combination of rib and lug design with enhanced tread profile gives good self-cleaning properties

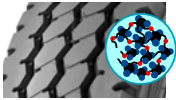
> The anti-cut-and-chip compound provides excellent protection against damage from impacts, cuts and abrasions

> 3PMSF Certified



FEATURES	BENEFITS
 <p>New casing construction with optimised tread profile</p>	Provides an optimal footprint for improved wear and vehicle handling
 <p>Combined rib and lug pattern design</p>	Delivers excellent traction and braking properties in all axle positions.
 <p>New casing construction with optimised tread profile</p>	Provides an optimal footprint for improved wear and vehicle handling
 <p>New, advanced anti-cut-and-chip compound</p>	High resistance against tread tearing from normal use on aggressive road surfaces

Size	LI	SI	Pattern		Rim	Load Single Kg	Load Dual Kg			Noise dB			
295/80R22.5	154/149 (152/149)	K (L)	GAM837	3PMSF	9.00	3750	3250	298	1044	73	B	C	C
315/70R22.5	156/150 (154/150)	K (L)	GAM837	3PMSF	9.00	4000	3350	312	1014	72	B	C	D

GDM686 GDM686+

MIXED SERVICE



GDM686 IS AN AGGRESSIVE DIRECTIONAL DEEP-TREAD DRIVE AXLE PATTERN FOR ON/OFF-ROAD APPLICATIONS



> Plus „+“ version for significant mileage increase compared to GDM686





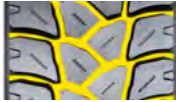

> Advanced anti-cut-and-chip compound with robust casing construction, providing high retreadability

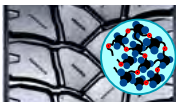
> Provides exceptional grip in rough terrain conditions as well as in winter conditions



FEATURES	BENEFITS
----------	----------

	<p>Big block with wide groove design</p>	<p>Delivers better traction and braking properties</p>
	<p>Directional extra-deep tread design with wide longitudinal grooves</p>	<p>Provides exceptional grip in rough terrain conditions with excellent self-cleaning properties and high resistance to damage</p>
	<p>Special anti-cut-and-chip compound formula</p>	<p>Provides excellent protection from tread cuts and damage in aggressive road and off-road conditions</p>

Size	LI	SI	Pattern		Rim	Load Single Kg	Load Dual Kg			Noise dB			
13R22.5	156/150	K	GDM686+	3PMSF	9.75	4000	3350	320	1124	73	A	B	E
11R22.5	148/145	J	GDM686	3PMSF	8.25	3150	2900	279	1054	73	A	B	E
12R22.5	152/148	K	GDM686	3PMSF	9.00	3550	3150	300	1085	73	A	B	E
295/80R22.5	152/149	K	GDM686	3PMSF	9.00	3550	3250	298	1050	73	A	B	D
315/80R22.5	158/150	K	GDM686	3PMSF	9.00	4250	3350	312	1076	73	A	B	D

Key Performance

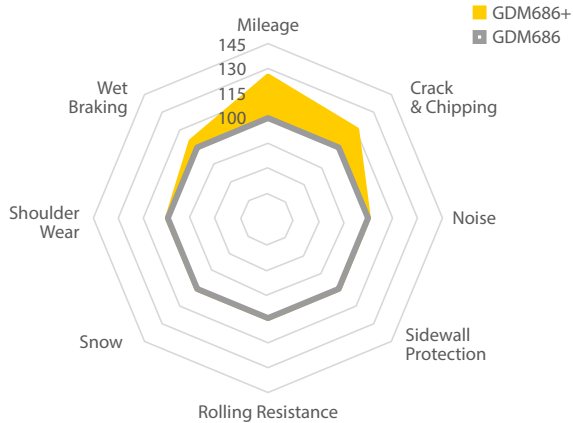

Field test in Europe

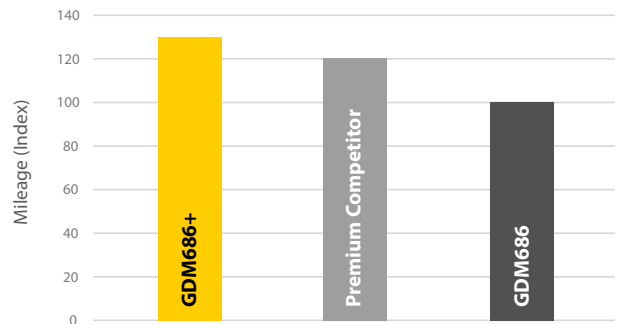

Internal test (2021) in size 13R22.5 in fleets in Italy

GAM851

MIXED SERVICE







NEW WIDE BASE STEER AND TRAILER DESIGN
PROVIDES EXCEPTIONAL PERFORMANCE IN ROUGH
TERRAIN APPLICATIONS







> Superb resistance to tread tearing, impacts, and casing damage in on/off-road conditions

> Very regular wear pattern, delivering excellent mileage performance

> 3PMSF Certified



FEATURES		BENEFITS
	Deep tread design with special anti-cut-and-chip compound	Superb resistance to tread tearing, impacts, and casing damage in on/off-road conditions
	Compact, three-groove design connected with multiple tie bars	Provides very regular wear and reduced noise levels
	Upper rubber sidewall protection ribs	Protects casing from impact, cuts and curb damage
 ROBUST CASING	Increased load index to 164 K	Fitment on 10-ton steer and trailer axles

Size	LI	SI	Pattern		Rim	Load Single Kg	Load Dual Kg			Noise dB			
385/65R22.5	164 (158)	K (L)	GAM851	3PMSF	11.75	5000		389	1072	72	B	B	C
425/65R22.5	165	K	GAM851	3PMSF	12.25	5150		422	1124	72	B	B	C
445/65R22.5	169	K	GAM851	3PMSF	13.00	5800		444	1150	72	B	B	C

URBAN



HIGHEST QUALITY STANDARDS ARE USED IN TIRES MANUFACTURED FOR URBAN APPLICATIONS TO ENSURE THE MAXIMUM LEVEL OF SAFETY, COMFORT, AND ENVIRONMENTAL SUSTAINABILITY, MATCHED WITH THE NEW TRENDS FOR FUTURE MOBILITY. THE TIRES ARE DESIGNED FOR ELECTRIC VEHICLE APPLICATIONS FEATURING THE LATEST TECHNOLOGICAL SOLUTIONS TO CARRY HIGH LOADS, REDUCE ENERGY CONSUMPTION, AND ENHANCE POTENTIAL MILEAGE. THE TIRES COMPLY WITH REQUIREMENTS FOR BOTH THE OLDER AND THE NEW GENERATION OF VEHICLES TO PROVIDE A FLEXIBLE SOLUTION FOR ALL EUROPEAN URBAN ENVIRONMENTS.

Product Offer

URBAN



GAU861

URBAN





DESIGNED SPECIFICALLY FOR BUSES OPERATING
IN URBAN CONDITIONS WITH FREQUENT STOPS,
CHANGES IN DIRECTION AND SPEED







> A high performing urban tire with reinforced sidewall protectors, robust casing construction, cap and base technology

> Super resistant to curbing and impact damage with good mileage performance this is combined with reduced noise levels for increased passenger comfort

> 3PMSF Certified



FEATURES		BENEFITS
	Wide and very deep tread	Provides excellent mileage performance pattern
	Numerous full tread depth sipes in tread blocks	Provides a very high level of winter traction and braking properties
	Reinforced sidewalls with asymmetric sidewall wear indicators	Protects the tire from curbing damages and abrasions, the sidewall wear indicator indicates the correct time to rotate or demount the tire

Size	LI	SI	Pattern		Rim	Load Single Kg	Load Dual Kg			Noise dB			
275/70R22.5	152/148 (150/148)	J (K)	GAU861	3PMSF	8.25	3350	2900	276	958	73	A	C	D

GT867

URBAN





GT867 IS SPECIALLY DESIGNED FOR CONSTANT STOP-AND-GO OPERATING CONDITIONS WITH FREQUENT CHANGES IN SPEED AS WELL AS DIRECTION





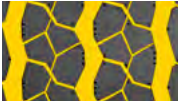

> An urban tire with reinforced sidewall, robust casing, cap and base construction technology

> Resistant to curb and impact damage, with good mileage performance combining comfort with reduced noise levels

> 3PMSF Certified



FEATURES		BENEFITS
	Very wide tread pattern with deep grooves	Provides excellent mileage
	Advanced tread block and siping in tread pattern	Reduces noise levels and improves passenger comfort
	Reinforced sidewalls with sidewall wear indicators	Protects the tire against curb damage and sidewall abrasion, and the wear indicators shows the correct time to rotate/demount the tire

Size	LI	SI	Pattern		Rim	Load Single Kg	Load Dual Kg			Noise dB			
245/70R19.5	136/134	M	GT867	3PMSF	7.50	2240	2120	248	839	70	A	B	E
11R22.5	148/145	J	GT867	3PMSF	8.25	3150	2900	279	1054	71	A	C	D
305/70R22.5	152/150 (154/150)	J (E)	GT867	M+S	9.00	3550	3350	305	1000	72	A	C	D
315/80R22.5	158/150	J	GT867	M+S	9.00	4250	3350	312	1076	72	A	C	C

GAU867^{V1}

URBAN







LATEST TIRE DEVELOPED FOR BUSES OPERATING
IN SEVERE URBAN CONDITIONS WITH FREQUENT
STOP-AND-START OPERATION







> Latest Giti development of urban
tire with new optimised casing
construction

> High resistance to curb and impact
damage, with excellent mileage
performance and high passenger
comfort

> 3PMSF Certified



FEATURES	BENEFITS
 <p>Wide and robust tread pattern coupled with new casing construction</p>	Enhances mileage performance and handling of vehicle
 <p>Advanced siping in centre of tread pattern</p>	Reduces noise levels and improves passenger comfort
 <p>Reinforced sidewalls with asymmetric sidewall wear indicators</p>	Protects the tire against curb damage and abrasions; the sidewall wear indicator indicates the correct time to rotate or demount the tire
 <p>E-Bus logo on sidewall in sizes 275/70R22.5 and 265/70R19.5</p>	Designed to meet next generation electric buses requirements

Size	LI	SI	Pattern		Rim	Load Single Kg	Load Dual Kg			Noise dB			
215/75R17.5	128/126	M	GAU867 ^{V1}	3PMSF	6.00	1800	1700	211	767	70	A	C	D
265/70R19.5	143/141	J	GAU867 ^{V1}	3PMSF	7.50	2725	2575	262	867	70	A	C	D
11R22.5	148/145	J	GAU867 ^{V1}	3PMSF	8.25	3150	2900	279	1054	71	A	C	D
275/70R22.5	152/148 (150/148)	J (K)	GAU867 ^{V1}	3PMSF	8.25	3550	3150	276	958	70	A	C	C
295/80R22.5	154/150	J	GAU867 ^{V1}	3PMSF	9.00	3750	3350	298	1050	71	A	C	D

WINTER



TIRES WITH SPECIFIC WINTER PROPERTIES FOR SUPERB SNOW TRACTION AND SAFE HANDLING FOR FLEETS OPERATING IN NORDIC REGIONS OR HIGH MOUNTAIN AREAS WHERE PROFESSIONAL WINTER CHARACTERISTICS ARE REQUIRED. THE LATEST TECHNOLOGY COMPOUNDS AND A DEEP-SIPE BASED TREAD PATTERN, PROVIDE EXCELLENT WINTER PERFORMANCE AND COMPETITIVE MILEAGE FOR SEVERE WINTER APPLICATIONS.





Product Offer

WINTER

GSW226

WINTER



STEER AND TRAILER AXLE PATTERN FOR SNOW,
ICE AND WET ROAD CONDITIONS

> 3PMSF tested and certified for
severe winter performance







> Excellent winter handling properties
with high mileage potential

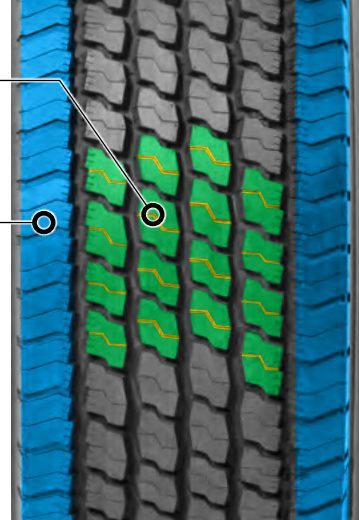

Optimized block edge elements in combination with deep snow sipes provide excellent grip and safe feeling in all road conditions.

Wide and robust shoulders ensure higher stability in steering and cornering keeping on the same time low noise and high driving comfort.



Size	LI	SI	Pattern		Rim	Load Single Kg	Load Dual Kg			Noise dB			
315/70R22.5	156/150 (154/150)	L (M)	GSW226	3PMSF	9.00	4000	3350	312	1014	72	B	C	D
315/80R22.5	158/150 (154/150)	L (M)	GSW226	3PMSF	9.00	4250	3350	312	1076	72	B	C	D
385/55R22.5	158 (160)	L (J)	GSW226	3PMSF	12.25	4250		386	996	73	B	B	D
385/65R22.5	164 (160)	K (L)	GSW226	3PMSF	11.75	5000		389	1072	72	B	B	D



GDR621+

WINTER



UPGRADED VERSION OF GITI DRIVE TIRE FOR
WINTER AND ALL SEASONS CONDITIONS

> GDR621+ features latest tread compound for improved road performances

> Fleet test run in Austria confirmed +30% mileage improvement while all other performances have been kept at same level

> Certified 3PMSF



Latest generation Giti tread compound for superior performance in winter and all-season conditions. Plus "+" on the sidewall stays for enhanced abrasion resistance tread compound vs. previous GDR621 generation.

Deep tread depth and specific block sipes for outstanding traction and excellent mileage in every condition.

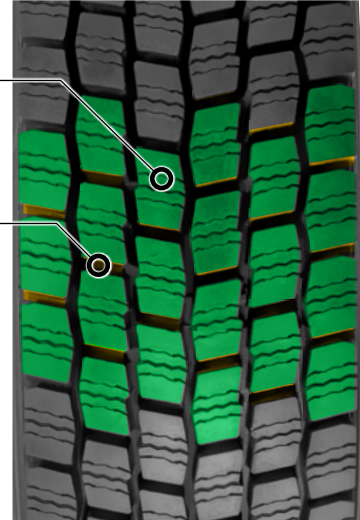

Size	LI	SI	Pattern		Rim	Load Single Kg	Load Dual Kg			Noise dB			
315/70R22.5	154/150 (152/148)	L (M)	GDR621+	3PMSF	9.00	3750	3350	312	1014	75	B	B	D
315/80R22.5	158/150 (154/150)	L (M)	GDR621+	3PMSF	9.00	4250	3350	312	1076	75	B	B	D

Key Performance

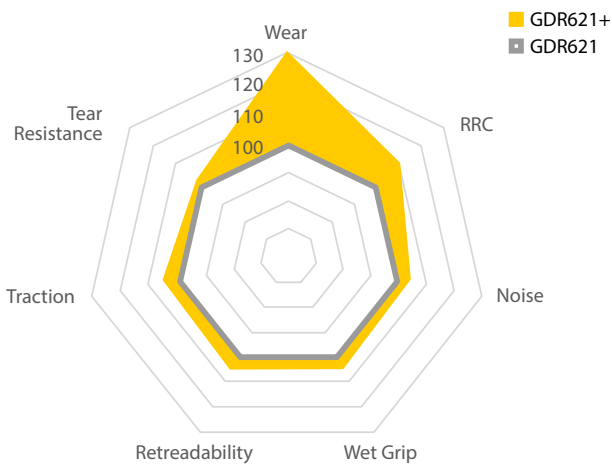

Giti Field test results in EU fleets

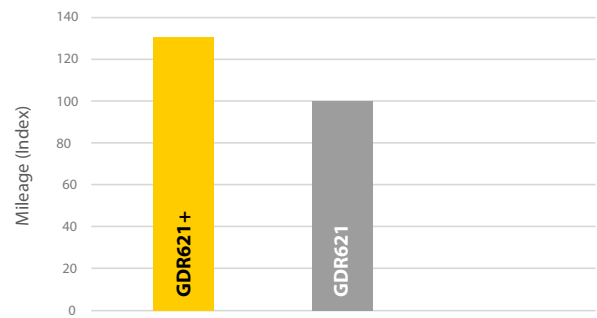

WHAT IS RETREADING?

It is the generic term for reconditioning a worn-out tire by replacing the worn tread with new material. It may also include renovation of the sidewall surface.

The use of modern retreaded truck tires represents a unique opportunity to lower transport costs and protect the environment without sacrificing safety and reliability. Technological developments over the last 25 years have been spectacular. Retreading means material savings by reducing the use of non-renewable raw materials (oil) and less waste on tires – the result is great environmental savings.

Within the EU, retreaded tires are submitted to the same safety tests as new tires, which guarantees that retreads can run for the same amount of kilometers as new tires, at a fraction of the cost.

Giti truck tires are built to be retreaded several times, depending on the application.

The Giti Genesis retread programme, operating in the UK market, demonstrates the high-quality of Giti Truck tires. Non-destructive inspection devices such as shearography use the latest laser technology to detect the very tiniest separation inside a used casing before and after processing the retread.

Giti casings are appreciated and listed on most quality retreaders acceptance lists, and for the end-user, purchasing new Giti tires means the casing will retain a competitive value when sold for retreading.



GTR991

> Giti Genesis is the Eco-friendly retreading program, using only high class certified Giti casings

> The GTR991 is a modern tread pattern designed for combined Urban, regional and long-distance applications

> Giti Genesis product are currently only available in certain European countries, please contact Giti for further details



FEATURES

Using only high quality inspected and approved Giti casings

Improved pattern design

Enhanced solid shoulder design

Optimised wide base footprint



BENEFITS

Quality assured performance

Delivers exceptional mileage performance and reduces the running costs of today's commercial vehicle operator

Provides protection against curbing and shoulder damage

Improves regular wear for increased mileage performance

Size	LI	SI	Pattern		Rim	Load Single Kg	Load Dual Kg		
385/65R22.5	160	J	GTR991	M+S	11.75	4500	389		1072

GDR690

> Giti Genesis is the Eco-friendly retreading program, using only high class certified Giti casings

> Extended mileage performance and regular wear, combined with excellent traction in dry, wet and winter conditions

> Giti Genesis product are currently only available in certain European countries, please contact Giti for further details



FEATURES

BENEFITS

New advanced tread design

Provides even wear and high mileage performance

Interlocking block arrangement



Ensures effective water evacuation and provides good self cleaning properties

Using high quality inspected and approved Giti casings

Quality assured performance

Deep grooves combined with optimised compound formula

Provides a high level of wet grip performance

Size	LI	SI	Pattern		Rim	Load Single Kg	Load Dual Kg		
295/80R22.5	152/149	K	GDR690	3PMSF	9.00	3550	3250	298	1044
315/80R22.5	156/150	K	GDR690	3PMSF	9.00	4000	3350	312	1076

GDR691

> Giti Genesis is the Eco-friendly retreading program, using only high class certified Giti casings

> New generation retread drive tire with non directional pattern and very flat wear profile

> Giti Genesis product are currently only available in certain European countries, please contact Giti for further details



FEATURES

Optimized tread blocks shape

High tie bar in shoulder area

Low heat generation tread compound

Very wide tread with 6-rib design



BENEFITS

Even press distribution in tire footprint

Improved pattern stiffness and shoulder robustness

Low rolling resistance, better casing durability and lower fuel consumption

Superior traction and best driving sensation

Size	LI	SI	Pattern		Rim	Load Single Kg	Load Dual Kg		
315/70R22.5	154/150	K	GDR691	3PMSF	9.00	3750	3350	312	1014

DESIGNATIONS, LOAD AND SPEED INDEX

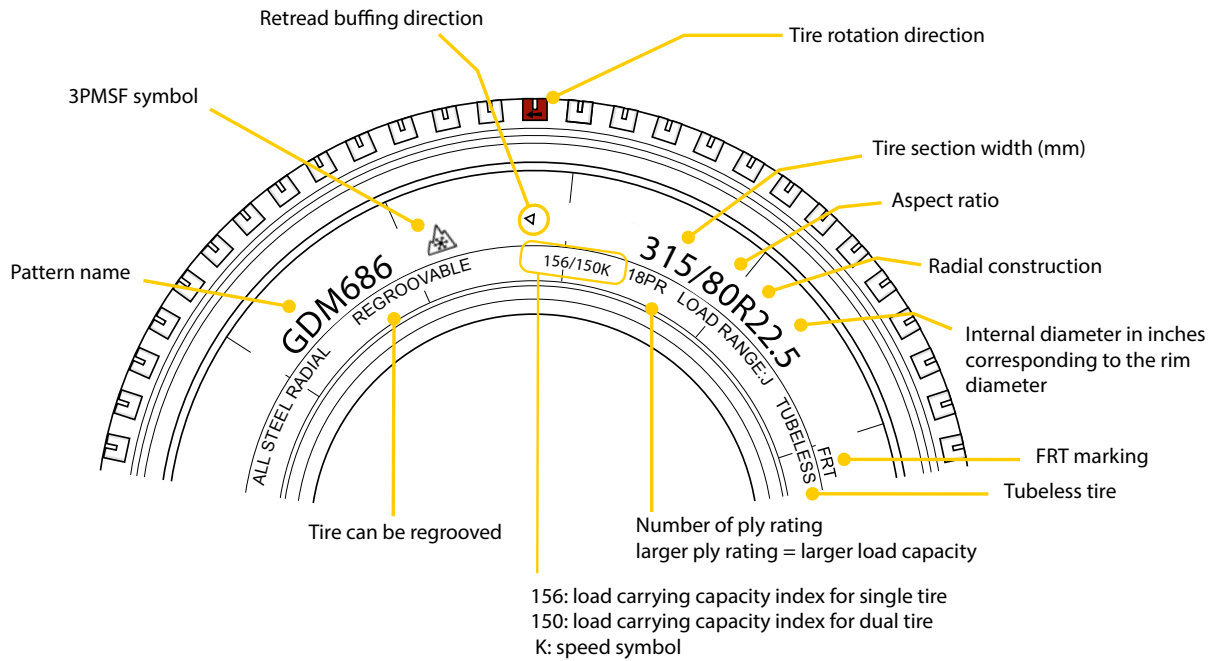

FRT: Tires bearing the “FRT” (Free Rolling Tire) marking are not designed for the equipment of front steering and drive axles but specifically for trailer and free rolling axles of motor vehicles. Giti Tire will not warrant or cannot be held accountable for any potential liability claim involving FRT tires fitted outside of these recommendations.

Refer to the speed symbols and load capacity index tables below.

SPEED SYMBOLS

SI	km/h
B	50
C	60
D	65
E	70
F	80
G	90
J	100
K	110
L	120
M	130
N	140
P	150
Q	160
R	170

LOAD CAPACITY INDEX

LI	kg	LI	kg	LI	kg
115	1215	136	2240	157	4125
116	1250	137	2300	158	4250
117	1285	138	2360	159	4375
118	1320	139	2430	160	4500
119	1360	140	2500	161	4625
120	1400	141	2575	162	4750
121	1450	142	2650	163	4875
122	1500	143	2725	164	5000
123	1550	144	2800	165	5150
124	1600	145	2900	166	5300
125	1650	146	3000	167	5450
126	1700	147	3075	168	5600
127	1750	148	3150	169	5800
128	1800	149	3250	170	6000
129	1850	150	3350	171	6150
130	1900	151	3450	172	6300
131	1950	152	3550	173	6500
132	2000	153	3650	174	6700
133	2060	154	3750	175	6900
134	2120	155	3875	176	7100
135	2180	156	4000	177	7300



Before fitting, it is essential to check the different markings to ensure that the tires meet the maximum load and speed possibilities, and/or the regulations in force.

NAMING CONVENTIONS

GSR 225

brand	axle	application
G: Giti	S: Steer	L: Long Haul
	D: Drive	R: Regional – Combi Road
	A: All Position	M: Mixed Service
	T: Trailer	O: Off-Road
		U: Urban
		C: Coach
		W: Winter



SIX STEPS TO SIMPLE TIRE MAINTENANCE

S Select the correct tire for your operating conditions
(Don't forget to select for new vehicles too!).

I Inflate your tires corresponding to the **LOAD** per **AXLE**
(See load Inflation tables).

M Maintain your tires by regular inspection and performance
monitoring (Don't forget the inflation pressure, tread,
and sidewalls, too).

P Protect your investment in Giti Tire products by retreading
the casing (Our tires are designed to have more than one
life).

L Lower your running costs by selecting the correct tire
for your application; managing your tires carefully will
obtain maximum mileage, fuel efficiency and retreading
performance out of your tire investment.

E Enjoy ongoing cost savings from Giti Group.

TIRE PRESSURE MANAGEMENT

INFLATION PRESSURE RECOMMENDATION

! SAFETY

Over-inflation reduces

- > Comfort
- > Grip
- > Safety
- > Braking distance
- > Tire life span, particularly on drive axle tires

Under-inflation leads to

- > Reduced vehicle handling and safety
- > A reduction in casing retreadability
- > An increase of fuel consumption

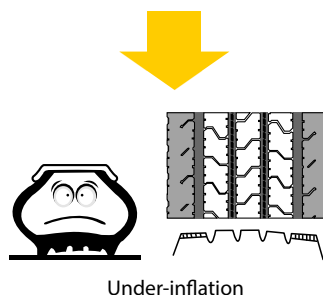
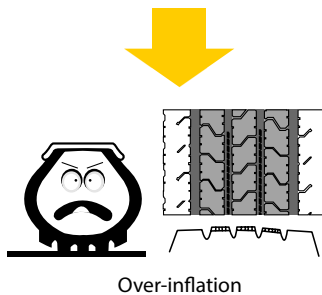

Effect of inflation pressure on tire life

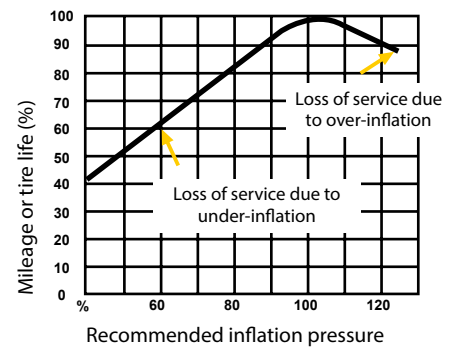

IMPORTANT INSTRUCTIONS FOR SAFE INFLATION

Advice before inflation

- 1 Weigh your vehicle and its load, axle by axle, to determine tire pressure.
- 2 Measure the pressure when cold (when the vehicle has been stationary for several hours): pressures must be checked at regular intervals and during each service.
- 3 Important safety instruction: pressure increases when the vehicle is in motion, never reduce the pressure of a hot tire.
- 4 Pressure gauges: must be accurate, handled with care, and calibrated regularly.

INFLATION METHOD



With inflation cage

- > Place the tire vertically in the inflation cage
- > Read the cage user manual



Without inflation cage

Step 1

Pre-inflate tire up to 1.5 bars and STOP

1.5 Bar

Check the tire. If in doubt, stop and call an expert

Step 2

Inflate up to the appropriate pressure







OK

3 m

During inflation, stand in line with the tire tread, at a minimum three meters away

! Caution: Driving with insufficient pressure can damage your tires. After having driven with an underinflated tire, do not re-inflate tires: have your tires fully checked by an expert.

TECHNICAL SPECIFICATIONS

	S Tire Section Width
	H Tire Sidewall Height
	R Unloaded Free Diameter
	R' Static Loaded Radius
	D Rolling Circumference
	E Min. Distance Tire Sidewalls in Twin Fitment
	T Tread Depth

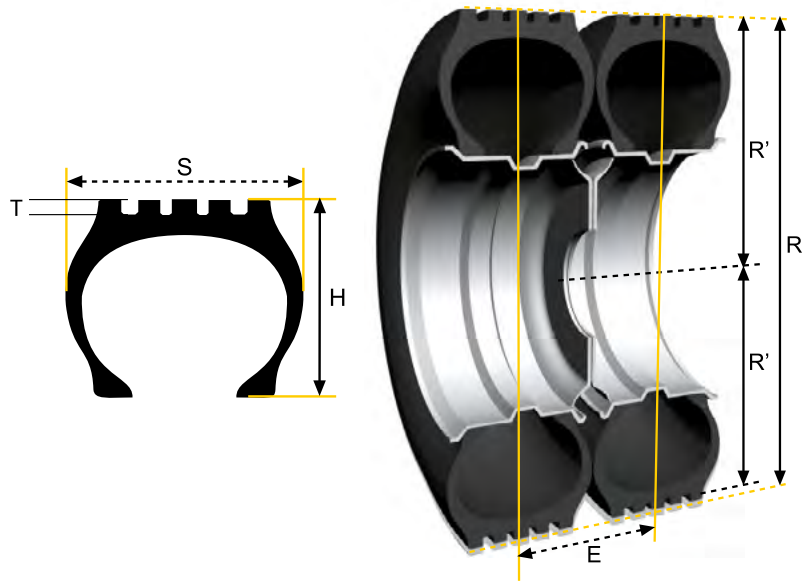

Load Capacity Variations According to Speed

SPEED (km/h)	LOAD CAPACITY VARIATION (%)						PRESSURE BALANCE (%)
	F	G	J	K	L	M	
0	+150	+150	+150	+150	+150	+150	40
5	+110	+110	+110	+110	+110	+110	40
10	+80	+80	+80	+80	+80	+80	30
15	+65	+65	+65	+65	+65	+65	25
20	+50	+50	+50	+50	+50	+50	21
25	+35	+35	+35	+35	+35	+35	17
30	+25	+25	+25	+25	+25	+25	13
35	+19	+19	+19	+19	+19	+19	11
40	+15	+15	+15	+15	+15	+15	10
45	+13	+13	+13	+13	+13	+13	9
50	+12	+12	+12	+12	+12	+12	8
55	+11	+11	+11	+11	+11	+11	7
60	+10	+10	+10	+10	+10	+10	6
65	+7.5	+8.5	+8.5	+8.5	+8.5	+8.5	4
70	+5.0	+7.0	+7.0	+7.0	+7.0	+7.0	2
75	+2.5	+5.5	+5.5	+5.5	+5.5	+5.5	1
80	[0]	4.0	+4.0	+4.0	+4.0	+4.0	0
85		2.0	+3.0	+3.0	+3.0	+3.0	0
90		[0]	+2.0	+2.0	+2.0	+2.0	0
95			+1.0	+1.0	+1.0	+1.0	0
100			[0]	0	0	0	0
110				[0]	0	0	0
120					[0]	0	0
130						[0]	0

The coefficients in this table are those of the ETRTO standard and are given for information only.

Contact us for all load capacities greater than the basic load limits given by tire markings and used in this brochure. When the coefficients in these tables lead to pressure greater than 10 bars, you must reduce the maximum load capacity to an amount which corresponds to a maximum pressure of 10 bars.

If you wish to use pressure greater than 10 bars, consult us about the tires, check the maximum resistance of rims with your rim manufacturer and comply with regulations in force for fitting and use. The coefficients indicated in this table are taken from the ETRTO.

Urban-bus or City bus (M3 – class I): +15% of the load indices marked on the tire, when the average speed does not exceed 40 km/h.

Sub-urban bus or Interurban bus (M3 – class II): + 10% of the load indices marked on the tire, when the operating speed is restricted to 60 km/h.

TIRE PRESSURE

The inflation pressures of tires for commercial vehicles must be adapted to the load, speed and conditions of use. Respecting the pressure of inflation is a prime factor in ensuring that the vehicle is safe when driving.

How Do I Determine Tire Pressure?

The fully loaded vehicle must be weighed by axle:

- Over inflation is bad for comfort, grip, and the tire's longevity.
- Insufficient pressure leads to an abnormal rise in the tire's temperature, leading to irreversible deterioration of its inner parts. This may cause destruction of the tire with a sudden blow-out.

The consequences of running with insufficient tire pressure are not necessarily immediate and may even become apparent only after correction. Tire pressure should be regularly checked when cold, using an accurate and regularly checked pressure gauge (according to the maker's recommendations).

Important:

- Don't forget the spare tire
- Never deflate a tire when "hot" just after running



WARNING: Any inflated tire mounted on a rim contains explosive energy. The use of damaged, mismatched or improperly assembled tire/rim parts can cause the assembly to burst apart with explosive force. If you are struck by an exploding tire, rim part, or the air blast, you can be seriously injured or killed.



WARNING: Tire and rim servicing can be dangerous and must be done only by trained personnel using proper tools and procedures. Failure to read and comply with all procedures may result in serious injury or death to you or others. Re-inflation of any type of tire and rim assembly that has been operated in a run-flat or underinflated condition (80% or less of recommended operating pressure) can result in serious injury or death. The tire may be damaged on the inside and can explode while you are adding air. The rim parts may be worn, damaged or dislodged, and can explosively separate. A tire running underinflated should not be returned to service until the interior has been carefully inspected by a specialist. The correct tire pressure is determined by the axle weight and driving conditions of the vehicle.

WINTER REGULATION

Operating a truck during the winter period sometimes requires special equipment. From the mild winter conditions of south Europe up to the most demanding Nordic winter roads, Giti truck tires provide diverse tire solutions. Depending on your fleet operations and winter road conditions, you can always find the right truck and bus tires with the right winter performance attested by M+S or 3PMSF certification, which is also required by local statutory regulations for winter truck or bus operations.

Pattern	Position	Application	M+S	3PMSF
GSR225	Steer	Combi Road	M+S	3PMSF
GSR236	Steer	Combi Road	M+S	3PMSF
GSR237	Steer	Combi Road	M+S	3PMSF
GSR259	Steer	Combi Road	M+S	3PMSF
GDR655	Drive	Combi Road	M+S	3PMSF
GDR655+	Drive	Combi Road	M+S	3PMSF
GDR665	Drive	Combi Road	M+S	3PMSF
GDR665+	Drive	Combi Road	M+S	3PMSF
GDR675	Drive	Combi Road	M+S	3PMSF
GTR955	Trailer	Combi Road	M+S	3PMSF
GDL617 ECO	Drive	Eco Road	M+S	3PMSF
GAL817	Steer	Long		
GDL617	Drive	Long	M+S	3PMSF
GTL919	Trailer	Long	M+S	3PMSF
GTL919+	Trailer	Long	M+S	3PMSF
GTL925	Trailer	Long	M+S	3PMSF
GAR820	All Position	Regional	M+S	3PMSF
GDR638	Drive	Regional	M+S	3PMSF
GDR688	Drive	Regional	M+S	3PMSF
GTR923	Trailer	Regional	M+S	3PMSF
GAM831	All Position	Mixed Service	M+S	3PMSF
GAM833	All Position	Mixed Service	M+S	
GAM837	All Position	Mixed Service	M+S	3PMSF
GDM676	Drive	Mixed Service	M+S	
GDM686	Drive	Mixed Service	M+S	3PMSF
GDM686+	Drive	Mixed Service	M+S	3PMSF
GAM851	All Position	Mixed Service	M+S	3PMSF
GAU861	All Position	Urban	M+S	3PMSF
GT867	All Position	Urban	M+S	3PMSF*
GAU867 ^{v1}	All Position	Urban	M+S	3PMSF
GSW226	Steer	Winter	M+S	3PMSF
GDR621+	Drive	Winter	M+S	3PMSF

*) only for sizes 245/70R19.5 and 11R22.5



LABELLING EXPLAINED

EU implemented in 2012 tire labelling requirements regarding the display of information on the fuel efficiency, wet grip, and external rolling noise of tires. (Regulation (EC) 1222/2009 with amendments (EC) 228/2011 and (EC) 1235/2011). Its aim was to increase the safety, the environmental and economic efficiency of road transport in Europe. The labelling will allow end-users to make more informed choices when purchasing tires. This labelling regulation was in operation for 8 years. To further enhance the tires safety and environmental information to the public, the regulation (EC) 1222/2009 was replaced with an upgraded regulation (EU) 2020/740. This regulation started to apply 1 May 2021.

The main upgrades can be summarized:

- The label layout will follow EU standard ECO labelling schemes
- Public access to label and product information sheet via QR code added to label
- Reorganisation of label classes
- Only classes A-E will be available
- Introduction of snow grip symbol on label (3PMSF)
- Label will be added to truck tires (was not required before)

Product Information Sheet

Delegated Regulation (EU) 2020/740

Supplier name or trademark		Giti Tire	
Commercial name or trade designation		GTR955	
Tyre type identifier	Tyre class	EV99984Q	C3
Tyre size designation		385/65R22.5	
Speed category symbol		K 110 km/h	
Load-capacity index (for single mounting)		164	
Load-capacity index (for dual mounting)		-	
Fuel efficiency class		B	
Wet grip class		B	
External rolling noise class	External rolling noise value	A	71 dB
Tire for use in severe snow conditions		Yes	
Load-capacity index for Additional Service Description (for single mounting)		158	
Load-capacity index for Additional Service Description (for dual mounting)		-	
Speed category symbol (for Additional Service Description)		L	
Date of start of production (Week / Year)		34/18	
Date of end of production (Week / Year)		-	
Supplier's address		Public Contact, Giti Tire Deutschland GmbH Hollerithallee 18a 30419 Hannover Germany	
Additional information		info in english	

The new labelling scheme covers passenger car, light truck, bus and truck tires. For further details on the new EU tire labelling regulation please visit the official EU Commission website.



All tires that are now placed on EU market, will have to be registered in the EU Ecodesign/labelling portal (EPREL). Beside access to the digital label itself, a product information sheet can be accessed.

The public have now also access, via this EU portal, to information about all tires placed on EU market. A public database has been made available to search for any product registered there.



We at Giti welcome this upgraded labelling system, we are convinced it will guide our customers towards using safer, quieter, and more fuel-efficient tires. Our Research and Development Team have taken great care in designing tires that meet the highest safety and environmental standards and we are confident it will satisfy our customers.

WHAT DOES THE LABEL INFORM ABOUT?

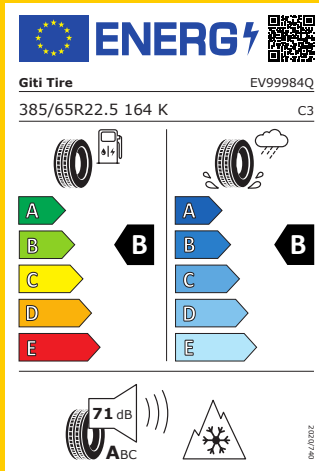

The tire label informs details of the manufacturer, internal product code, tire size description and tire class.

It grades 4 Performance criteria:

- Fuel efficiency
- Wet Grip
- Exterior noise from contact with the road surface
- Snow grip

For fuel efficiency and wet grip, performance is expressed in 5 classes ranging from A (the most efficient) to E (the least efficient).

For noise, the measured value is present on the label together with the letters A, B, and C (A is the lowest noise rating and C is the highest noise rating).

FUEL EFFICIENCY

Fuel consumption is influenced by tire deformation when rotating, resulting in energy losses in the form of heat. This is called the rolling resistance of the tire. The higher the deformation, the higher the tire rolling resistance and consequently more fuel is required to move the vehicle forward. In other words, lower rolling resistance means lower fuel consumption and therefore lower vehicle emissions, including CO₂.

The label displays different grades in "rolling resistance" where A is the most "fuel efficient" and E the least efficient in class. The black arrow next to the grading indicates the performance level of the product.

Customers should be made aware that the actual fuel savings and road safety depend heavily on the behaviour of drivers, in particular the following: eco-driving can significantly reduce fuel consumption; the tire pressure needs to be correct and regularly checked for optimum fuel and wet grip efficiency and safety.

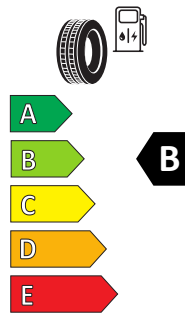

WET GRIP

The most important role of a tire is to provide safety – in all weather conditions. Wet traction or grip is one of the most important performance characteristics of any tire.

There is typically a performance trade-off when combining noise, fuel efficiency and safety performances like wet grip. The labelling will allow customers to prioritise for themselves their preferred performances.

The label will display a range of 5 grades where tires with an "A" provide the highest levels of wet grip and "E" the lowest. Note: You should always respect the recommended stopping distances and keep safe distances when driving.

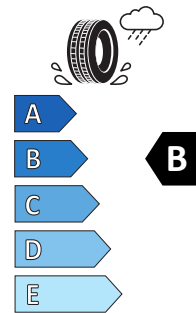

SNOW GRIP

When the label has the 3PMSF symbol, it guarantees real winter performance by being specifically designed for snow use and the tire has passed a regulated objective test set out in ECE117, indicating it has a certain level of better snow traction than a so called SRTT tire. (Standard Reference Test Tire).



EXTERIOR NOISE

Exterior tire noise levels are split into 3 categories and measured in decibel (dB) in comparison with the EU Regulative noise levels (ECE117).

A = 3dB less than the current EU limit value for this product.





B = Compliant with the current EU limit value for this product.





C = Non-compliant with the current EU limit value for this product.

An increase of just a few decibels represents a big difference in noise levels. In fact, a difference of 3dB doubles the amount of external noise from the tire.







EAN CODES, ECE CERTIFICATIONS AND EU LABELLING DATA





Factory	Dimension	LI	SI	Pattern		Code	EAN	ECE54	ECE117	EPREL	d(B)			
17.5-90														
FJ	9.5R17.5	143/141	K	GAR820	3PMSF	EV1581Q	6932877100979	E4-0031841	E4-025002 S2WR2	472955	74	B	C	E
17.5-75														
FJ	205/75R17.5	124/122	M	GAR820	3PMSF	EV1201Q	6932877100306	E4-0026054	E4-025002 S2WR2	472939	71	A	D	D
FJ	205/75R17.5	124/122	M	GSR236	3PMSF	EV1204Q	6932877132000	E4-0026054	E4-0212363 S2WR2	1518650	67	A	B	D
FJ	205/75R17.5	124/122	M	GDR638	3PMSF	EV1202Q	6932877166081	E4-0026054	E4-026402 S2WR2	472940	74	B	C	D
FJ	215/75R17.5	128/126	M	GAR820	3PMSF	EV1713Q0	6932877126054	E4-0034125	E4-025002 S2WR2	770426	71	A	D	D
FJ	215/75R17.5	128/126	M	GSR236	3PMSF	EV1718Q	6932877128737	E4-0034125	E4-0212363 S2WR2	1125551	67	A	B	D
FJ	215/75R17.5	128/126	M	GAU867 ^{VI}	3PMSF	EV1715Q	6932877129086	E4-0034125	E4-029784 S2WR2	472961	70	A	C	D
AH	215/75R17.5	126/124	M	GDR638	3PMSF	EV1712Q	6924699166103	E4-0015320	E4-026402 S2WR2	472959	74	B	C	D
IND	215/75R17.5	126/124	M	GDR638	3PMSF	EV99941Q	8990876718913	E4 0041643	E4 0211425 S2WR2	898616	74	B	C	E
IND	215/75R17.5	136/134	K	GTR955	3PMSF	EV99901Q	8990876740129	E4 0043628	E4 0211516 S2WR2	898556	66	A	B	C
FJ	225/75R17.5	129/127	M	GAR820	3PMSF	EV1211Q	6932877103192	E4-0026055	E4-025002 S2WR2	472941	71	A	D	D
FJ	225/75R17.5	129/127	M	GSR236	3PMSF	EV1213Q	6932877132154	E4-0026055	E4-0212363 S2WR2	1463407	69	A	B	D
FJ	225/75R17.5	129/127	M	GDR638	3PMSF	EV1212Q	6932877100511	E4-0026055	E4-026402 S2WR2	472942	74	B	C	D
IND	235/75R17.5	132/130	M	GAR820	3PMSF	EV99973Q	8990876714328	E4-54R-0030848	E4 027611 S2WR2	898614	71	A	C	D
AH	235/75R17.5	132/130	M	GAR820	3PMSF	EV1077Q2	6924699189829	E4-0015322	E4-025002 S2WR2	1327494	71	A	C	D
FJ	235/75R17.5	132/130	M	GSR236	3PMSF	EV2640Q	6932877131676	E4-0050771	E4-0212363 S2WR2	1441088	69	A	B	C
FJ	235/75R17.5	132/130	M	GDR638	3PMSF	EV2140Q	6924699186675	E4-0015322	E4-026402 S2WR2	472972	74	B	C	D
IND	235/75R17.5	143/141 (146/146)	K (F)	GTR955	3PMSF	EV99903Q	8990876740136	E4 0047459	E4 0211516 S2WR2	898558	67	A	B	C
17.5-70														
FJ	245/70R17.5	136/134	M	GAR820	3PMSF	EV878Q	6932877128799	E4-0026056	E4-025002 S2WR2	473000	74	B	C	D
FJ	245/70R17.5	136/134	M	GSR236	3PMSF	EV876Q	6932877131287	E4-0026056	E4-0212363 S2WR2	1441090	69	A	B	D
FJ	245/70R17.5	136/134	M	GDR638	3PMSF	EV877Q	6932877129093	E4-0026056	E4-026402 S2WR2	472999	74	B	C	D
IND	245/70R17.5	143/141 (146/146)	K (F)	GTR955	3PMSF	EV99902Q	8990876740143	E4 0047901	E4 0211516 S2WR2	898557	67	A	B	C
19.5-70														
FJ	245/70R19.5	136/134	M	GSR225	3PMSF	EV2290Q	6932877105301	E4-0033087	E4-024999 S2WR2	472978	71	A	C	C
FJ	245/70R19.5	136/134	M	GT867	3PMSF	EV755Q	6932877129123	E4-0033087	E4-0211606 S2WR2	472991	70	A	B	E
FJ	245/70R19.5	136/134	M	GDR638	3PMSF	EV757Q	6932877129093	E4-0033087	E4-026402 S2WR2	472992	75	B	C	D
FJ	245/70R19.5	141/140	J	GTL919	3PMSF	EV752Q	6932877128591	E4-0033086	E4-025425 S2WR2	472990	69	A	C	C
FJ	265/70R19.5	140/138	M	GSR225	3PMSF	EV1461Q	6932877128782	E4-0033089	E4-024999 S2WR2	472950	71	A	C	D
FJ	265/70R19.5	143/141	J	GAU867 ^{VI}	3PMSF	EV567Q	6932877130457	E4-0026058	E4-029784 S2WR2	472984	70	A	C	D
FJ	265/70R19.5	140/138	M	GDR638	3PMSF	EV1462Q	6932877129079	E4-0033089	E4-026402 S2WR2	472951	75	B	C	D
FJ	265/70R19.5	143/141	J	GTL919	3PMSF	EV568Q	6932877114945	E4-0033088	E4-025425 S2WR2	472985	69	A	C	C
FJ	265/70R19.5	143/141	J	GTR923	3PMSF	EV785Q	6932877111128	E4-0026058	E4-024998 S2WR2	472993	72	B	C	D

Factory	Dimension	LI	SI	Pattern		Code	EAN	ECE54	ECE117	EPREL	d(B)			
FJ	285/70R19.5	146/145	M	GSR225	3PMSF	EV1840Q	6932877128683	E4-0035318	E4-024999 S2WR2	472968	71	A	C	C
FJ	285/70R19.5	146/145	M	GDR638	3PMSF	EV722Q	6932877128744	E4-0035318	E4-026402 S2WR2	472988	75	B	B	D
FJ	285/70R19.5	150/148	J	GTL919	3PMSF	EV721Q	6932877128751	E4-0019382	E4-025425 S2WR2	472987	69	A	C	C
19.5-WIDE														
FJ	435/50R19.5	164	J	GTL925	3PMSF	EV1302Q	6932877109750	E4-0041242	E4-025595 S2WR2	472943	69	A	D	C
FJ	435/50R19.5	164	J	GTL925	3PMSF	EV1021Q	6932877109576	E4-0041243	E4-025595 S2WR2	472932	69	A	C	B
22.5-90														
AH	9R22.5	136/134	M	GAL817	*	EV1933Q0	6924699181243	E4-0013414	E4-022507 S2WR2	472970	70	A	C	E
AH	10R22.5	144/142	M	GAL817	*	EV1354Q1	6924699181311	E4-0022616	E4-022507 S2WR2	1363829	70	A	C	D
FJ	10R22.5	144/142	M	GDR688	3PMSF	EV1350Q	6932877129062	E4-0028647	E4-0210448 S2WR2	472945	74	B	C	D
IND	11R22.5	148/145	M	GSR225	3PMSF	EV91752Q	8990876715547	E4-54R-0038168	E4 029634 S2WR2	898605	71	A	C	D
AH	11R22.5	149/146	M	GSR237	3PMSF	EV2510Q	6924699180000	E4-0048580	E4-0212356 S2WR2	1441087	70	A	B	C
IND	11R22.5	148/145	J	GT867	3PMSF	EV91753Q	8990876715943	E4-54R-0038170	E4 0210254 S2WR2	898606	71	A	C	D
AH	11R22.5	148/145	J	GAU867 ^{v1}	3PMSF	EV1990Q	6924699186965	E4-0020878	E4-029784 S2WR2	472971	71	A	C	D
AH	11R22.5	148/145	K	GAM839	M+S	EV1751Q	6924699189263	E4-0035910	E4-028469 S2WR2	472965	71	B	C	D
IND	11R22.5	148/145	M	GDR655	3PMSF	EV91755Q	8990876715745	E4-54R-0038169	E4 029633 S2WR2	898615	74	B	C	E
AH	11R22.5	148/145	J	GDM686	3PMSF	EV2334Q	6924699179189	E4-0020878	E4-020434 S2WR2	770427	73	A	B	E
FJ	12R22.5	152/149	L	GSR225	3PMSF	EV1549Q	6932877103499	E4-0033394	E4-024999 S2WR2	472952	71	A	C	D
AH	12R22.5	152/149	M	GSR237	3PMSF	EV2711Q	6924699176003	E4-0033099	E4-0212356 S2WR2	1463409	70	A	B	C
FJ	12R22.5	152/148	K	GDM686	3PMSF	EV366Q	6932877130440	E4-0024027	E4-020434 S2WR2	472981	73	A	B	E
FJ	13R22.5	156/150 (154/150)	K (L)	GAM831	3PMSF	EV429Q	6932877128614	E4-0019844	E4-024052 S2WR2	472983	74	B	B	D
FJ	13R22.5	156/150	K	GDM686	3PMSF	EV1068Q	6932877129055	E4-0035957	E4-020434 S2WR2	472934	73	A	B	E
FJ	13R22.5	156/150	K	GDM686+	3PMSF	EV1069Q	6932877128690	E4-0035957	E4-020434 S2WR2	1342833	73	A	B	E
22.5-80														
IND	295/80R22.5	154/149	M	GSR225	3PMSF	EV91313Q	8990876715561	E4-54R-0038172	E4 029634 S2WR2	898571	72	B	B	D
FJ	295/80R22.5	154/149	M	GSR225	3PMSF	EV1313Q	6932877139443	E4-0029058	E4-024999 S2WR2	565406	71	A	B	C
FJ	295/80R22.5	154/149	M	GSR237	3PMSF	EV2456Q	6932877118592	E4-0029058	E4-0212356 S2WR2	1342834	70	A	B	C
IND	295/80R22.5	154/150	J	GAU867 ^{v1}	3PMSF	EV91794Q	8990876716360	E4-54R-0038174	E4 029767 S2WR2	898607	71	A	C	D
AH	295/80R22.5	154/150	J	GAU867 ^{v1}	3PMSF	EV1795Q	6924699186972	E4-0035956	E4-029784 S2WR2	565413	71	A	C	D
FJ	295/80R22.5	154/149 (152/149)	K (L)	GAM837	3PMSF	EV1656Q	6932877139436	E4-0033316	E4-027667 S2WR2	472956	73	B	C	C
AH	295/80R22.5	152/148	M	GDL617	3PMSF	EV1161Q	6924699188587	E4-0015306	E4-021587 S2WR2	472936	74	B	C	C
FJ	295/80R22.5	152/149	M	GDR655	3PMSF	EV1657Q	6932877105233	E4-0023963	E4-026631 S2WR2	472957	74	B	C	D
FJ	295/80R22.5	152/149	M	GDR665	3PMSF	EV1761Q	6932877106360	E4-0023963	E4-028267 S2WR2	1082416	76	B	C	D
IND	295/80R22.5	152/149	M	GDR665+	3PMSF	EV99937Q	8990876741171	E4 0038173	E4 029986 S2WR2	898608	76	B	C	D
FJ	295/80R22.5	152/149	M	GDR675	3PMSF	EV2451Q	6932877124678	E4-0023963	E4-0211824 S2WR2	1184183	71	A	B	D

* To be announced







EAN CODES, ECE CERTIFICATIONS AND EU LABELLING DATA

Factory	Dimension	LI	SI	Pattern		Code	EAN	ECE54	ECE117	EPREL	d(B)				
FJ	295/80R22.5	152/149	K	GDM686	3PMSF	EV2452Q	6932877128911	E4-0020880	E4-020434 S2WR2	472982	73	A	B	D	
IND	315/80R22.5	158/150 (154/150)	L (M)	GSR225	3PMSF	EV99963Q	8990876715585	E4 0041634	E4 029634 S2WR2	898562	71	A	B	C	
FJ	315/80R22.5	158/150 (154/150)	L (M)	GSR225	3PMSF	EV1980Q	6932877109262	E4-0028980	E4-024999 S2WR2	565417	71	A	B	C	
FJ	315/80R22.5	158/150 (154/150)	L (M)	GSR237	3PMSF	EV1982Q	6932877131058	E4-0028980	E4-0212356 S2WR2	1398749	70	A	B	C	
FJ	315/80R22.5	158/150	J	GT867	M+S	EV1416Q	6932877128768	E4-0033767	E4-027523 S2WR2	472948	72	A	C	C	
IND	315/80R22.5	158/150 (154/150)	K (L)	GAM831	3PMSF	EV99951Q	8990876718371	E4 0041631	E4 0210479 S2WR2	898574	73	A	B	D	
AH	315/80R22.5	158/150 (154/150)	K (L)	GAM831	3PMSF	EV2200Q	6924699186408	E4-0035909	E4-024052 S2WR2	565419	73	A	B	D	
FJ	315/80R22.5	158/150 (154/150)	L (M)	GSW226	3PMSF	EV1801Q	6932877129116	E4-0028980	E4-025742 S2WR2	472967	72	B	C	D	
IND	315/80R22.5	156/150 (154/150)	L (M)	GDL617	3PMSF	EV99952Q	8990876718784	E4 0041630	E4 0210449 S2WR2	898611	74	B	C	D	
AH	315/80R22.5	156/150 (154/150)	L (M)	GDL617	3PMSF	EV1419Q	6924699188563	E4-0019842	E4-021587 S2WR2	1082414	74	B	C	D	
AH	315/80R22.5	156/150 (154/150)	L (M)	GDR655	3PMSF	EV1806Q	6924699186958	E4-0019842	E4-026631 S2WR2	565414	74	B	C	E	
IND	315/80R22.5	156/150 (154/150)	L (M)	GDR655+	3PMSF	EV99938Q	8990876740990	E4 0041633	E4 029633 S2WR2	898609	74	B	C	D	
FJ	315/80R22.5	156/150 (154/150)	L (M)	GDR665	3PMSF	EV1418Q	6932877113863	E4-0019842	E4-028267 S2WR2	472949	76	B	B	D	
FJ	315/80R22.5	156/150 (154/150)	L (M)	GDR675	3PMSF	EV2206Q	6932877124463	E4-0019842	E4-0211824 S2WR2	1184182	71	A	B	D	
FJ	315/80R22.5	158/150 (154/150)	L (M)	GDR621+	3PMSF	EV1983Q	6932877127730	E4-0028980	E4-021586 S2WR2	1327495	75	B	B	D	
FJ	315/80R22.5	158/150	K	GDM686	3PMSF	EV2203Q	6932877122599	E4-0047161	E4-020434 S2WR2	610948	73	A	B	D	
IND	315/80R22.5	158/150	K	GDM686	3PMSF	EV99893Q	8990876718180	E4 0047448	E4 0211926 S2WR2	898572	73	A	B	D	
FJ	315/80R22.5	156/150	K	GDM687	3PMSF	EV2204Q	6932877122803	E4-0017511	E4-0212355 S2WR2	1327496	74	B	B	D	
22.5-70															
FJ	255/70R22.5	140/137	M	GAL817	*	EV1893Q1	6932877127976	E4-0014365	E4-022507 S2WR2	1363830	70	A	C	C	
FJ	275/70R22.5	148/145 (152/148)	M (J)	GSR225	3PMSF	EV2174Q	6932877128621	E4-0033090	E4-024999 S2WR2	472974	71	A	C	C	
FJ	275/70R22.5	148/145 (152/148)	M (J)	GSR237	3PMSF	EV2179Q	6932877125453	E4-0033090	E4-0212356 S2WR2	1441086	69	A	B	C	
AH	275/70R22.5	152/148 (150/148)	J (K)	GAU861	3PMSF	EV2212Q	6924699176775	E4-0050772	E4-022508 S2WR2	1392749	73	A	C	D	
FJ	275/70R22.5	152/148 (150/148)	J (K)	GAU867 ^{vi}	3PMSF	EV2614Q	6932877131690	E4-0050772	E4-029784 S2WR2	1363832	70	A	C	C	
AH	275/70R22.5	148/145	K	GDM676	3PMSF	EV626Q	6924699187801	E4-0018790	E4-020172 S2WR2	472986	75	B	D	D	
AH	305/70R22.5	152/150 (154/150)	J (E)	GT867	M+S	EV1340Q	6924699133822	E4-0029059	E4-027523 S2WR2	472944	72	A	C	D	
IND	315/70R22.5	156/150 (154/150)	L (M)	GSR225	3PMSF	EV99896Q	8990876715592	E4 0041636	E4 029634 S2WR2	898555	71	A	B	C	
FJ	315/70R22.5	156/150 (154/150)	L (M)	GSR225	3PMSF	EV2403Q	6932877121400	E4-0026385	E4-024999 S2WR2	565421	71	A	B	C	
FJ	315/70R22.5	156/150 (154/150)	L (M)	GSR237	3PMSF	EV2580Q	6932877127839	E4-0032379	E4-0212356 S2WR2	1184184	70	A	B	C	
AH	315/70R22.5	156/150 (154/150)	K (L)	GAM837	3PMSF	EV1721Q	6924699139763	E4-0033766	E4-027667 S2WR2	472962	72	B	C	D	
FJ	315/70R22.5	156/150 (154/150)	L (M)	GSW226	3PMSF	EV1178Q	6932877129109	E4-0032379	E4-025742 S2WR2	472938	72	B	C	D	
IND	315/70R22.5	154/150 (152/148)	L (M)	GDL617	3PMSF	EV99953Q	8990876718777	E4 0041635	E4 0210449 S2WR2	898612	74	B	C	D	
AH	315/70R22.5	154/150 (152/148)	L (M)	GDL617	3PMSF	EV1722Q	6924699188761	E4-0016124	E4-021587 S2WR2	565409	74	B	C	D	
FJ	315/70R22.5	154/150 (152/148)	L (M)	GDL617 ECO	3PMSF	EV2581Q	6924699177956	E4-0016124	E4-021587 S2WR2	*	74	B	C	B	
FJ	315/70R22.5	154/150 (152/148)	L (M)	GDR621+	3PMSF	EV1729Q	6932877127266	E4-0016124	E4-021586 S2WR2	858739	75	B	B	D	
FJ	315/70R22.5	154/150 (152/148)	L (M)	GDR655	3PMSF	EV2402Q	6932877120267	E4-0016124	E4-026631 S2WR2	565420	76	B	B	D	
IND	315/70R22.5	154/150 (152/148)	L (M)	GDR655+	3PMSF	EV99939Q	8990876740983	E4 0041637	E4 029633 S2WR2	898610	74	B	C	D	

Factory	Dimension	LI	SI	Pattern		Code	EAN	ECE54	ECE117	EPREL	d(B)				
FJ	315/70R22.5	154/150 (152/148)	L (M)	GDR675	3PMSF	EV1727Q	6932877115386	E4-0016124	E4-0211824 S2WR2	472963	71	A	B	D	
22.5-65															
IND	385/65R22.5	164 (160)	K (L)	GSR259	3PMSF	EV99983Q	8990876716582	E4 0040855	E4 0210230 S2WR2	898563	70	A	B	C	
FJ	385/65R22.5	164 (160)	K (L)	GSR259	3PMSF	EV1744Q	6932877104045	E4-0036010	E4-020895 S2WR2	565410	70	A	B	C	
IND	385/65R22.5	164 (160)	K (L)	GSW226	3PMSF	EV99950Q	8990876717589	E4 0040331	E4 0210450 S2WR2	898573	72	B	B	D	
FJ	385/65R22.5	164 (160)	K (L)	GSW226	3PMSF	EV1747Q	6932877129178	E4-0036010	E4-025742 S2WR2	565411	72	B	B	D	
FJ	385/65R22.5	164 (158)	K (L)	GTL919+	3PMSF	EV1746Q	6932877106391	E4-0035295	E4-025425 S2WR2	472964	69	A	B	B	
IND	385/65R22.5	164 (158)	K (L)	GTR955	3PMSF	EV99984Q	8990876716780	E4-54R-0038182	E4 029766 S2WR2	898553	71	A	B	B	
IND	385/65R22.5	164 (158)	K (L)	GAM851	3PMSF	EV99949Q	8990876740594	E4 0041330	E4 029768 S2WR2	898559	72	B	B	C	
FJ	385/65R22.5	164 (158)	K (L)	GAM851	3PMSF	EV2130Q	6932877109781	E4-0035295	E4-028269 S2WR2	565418	72	B	B	C	
FJ	425/65R22.5	165	K	GTL919	3PMSF	EV853Q	6932877129130	E4-0024028	E4-025425 S2WR2	472996	69	A	B	C	
FJ	425/65R22.5	165	K	GAM851	3PMSF	EV854Q	6932877128775	E4-0024028	E4-028269 S2WR2	472997	72	B	B	C	
FJ	445/65R22.5	169	K	GAM851	3PMSF	EV841Q	6932877128706	E4-0017314	E4-028269 S2WR2	472995	72	B	B	C	
22.5-60															
FJ	295/60R22.5	150/147	L	GSR225	3PMSF	EV1562Q	6932877106483	E4-0038065	E4-024999 S2WR2	472954	71	A	B	C	
FJ	295/60R22.5	150/147	L	GSR237	3PMSF	EV1563Q	6932877119148	E4-0038065	E4-0212356 S2WR2	1441084	70	A	B	D	
FJ	295/60R22.5	150/147 (149/146)	K (L)	GDL617	3PMSF	EV1560Q	6932877103567	E4-0025883	E4-021587 S2WR2	472953	74	B	C	D	
FJ	295/60R22.5	150/147 (149/146)	K (L)	GDR675	3PMSF	EV1564Q	6932877132932	*	*	*	*	*	*	*	
FJ	315/60R22.5	154/148	L	GSR225	3PMSF	EV347Q	6932877128638	E4-0026121	E4-024999 S2WR2	472980	71	A	C	C	
FJ	315/60R22.5	156/150	L	GSR237	3PMSF	EV346Q	6932877130884	E4-0050780	E4-0212356 S2WR2	1441089	71	A	B	C	
FJ	315/60R22.5	152/148	L	GDL617	3PMSF	EV342Q	6932877128652	E4-0023685	E4-021587 S2WR2	472979	74	B	B	D	
FJ	315/60R22.5	152/148	L	GDR675	3PMSF	EV2661Q	6932877131263	E4-0023685	E4-0211824 S2WR2	1375414	71	A	B	D	
22.5-55															
IND	385/55R22.5	158 (160)	L (K)	GSR259	3PMSF	EV99956Q	8990876716575	E4 0041628	E4 0210230 S2WR2	898560	70	A	B	C	
FJ	385/55R22.5	158 (160)	L (K)	GSR259	3PMSF	EV826Q	6932877128720	E4-0019383	E4-020895 S2WR2	565423	70	A	B	C	
FJ	385/55R22.5	160 (158)	K (L)	GTL919	3PMSF	EV2410Q	6932877120465	E4-0026803	E4-025425 S2WR2	565422	71	A	B	C	
IND	385/55R22.5	164	K (L)	GTR955	3PMSF	EV99954Q	8990876716773	E4 0040332	E4 029766 S2WR2	898552	69	A	B	B	
IND	385/55R22.5	158 (160)	L (J)	GSW226	3PMSF	EV99955Q	8990876717572	E4 0041629	E4 0210450 S2WR2	898575	73	B	B	D	
FJ	385/55R22.5	158 (160)	L (J)	GSW226	3PMSF	EV827Q	6932877127969	E4-0032380	E4-025742 S2WR2	565424	73	B	B	D	
FJ	355/50R22.5	156	L	GSR237	3PMSF	EV1940Q	6932877120915	E4-0048579	E4-0212356 S2WR2	1066087	70	A	B	B	
24-SIZES															
FJ	12.00R24	160/156	K	GAM833	M+S	EV1055Q	6932877111838	E4-0032623	E4-028360 S2WR2	472933	73	B	C	C	
FJ	325/95R24	162/160	K	GAM833	M+S	EV1662Q	6932877112033	E4-0036141	E4-028360 S2WR2	472958	73	B	B	C	

* To be announced







TECHNICAL DATA

TECHNICAL SPECIFICATIONS																	Per Tire				
Bead	Series	Size	Pattern	Index	Index 2	PR		Type		Approved Rim					TD	Min Dual	Load Single	Load Dual	Index	S=Single	D=Dual
16	100	7.50R16	GAR859	122/118L		14	M+S	TT	6.00G	5.50F; 6.50H	215	802	375	2446	14.5	242	1500	1320	122	S	
			GDM607	122/118K		14	M+S	TT								15.0				118	D
16	100	8.25R16	GAR859	128/124M		14	M+S	TT	6.50H	6.00G	235	860	397	2623	14.5	269	1800	1600	128	S	
			GDM607	128/124K		14	M+S	TT								15.0				124	D
17.5	90	9.5R17.5	GAR820	143/141K		16	3PMSF	TL	6.00	6.75	240	842	395	2567	12.5	245	2725	2575	143	S	
																			141	D	
17.5	75	205/75R17.5	GAR820	124/122M		12	3PMSF	TL	6.00	5.25; 6.75	205	753	350	2297	12.5	239	1600	1500	124	S	
			GSR236	124/122M		12	3PMSF	TL							13.0				122	D	
			GDR638	124/122M		12	3PMSF	TL								14.0					
17.5	75	215/75R17.5	GAR820	128/126M		14	3PMSF	TL	6.00	6.75	211	767	360	2339	13.0	239	1800	1700	128	S	
			GSR236	128/126M		14	3PMSF	TL							13.0				126	D	
			GAU867 ^{VI}	128/126M		14	3PMSF	TL							13.5						
17.5	75	215/75R17.5	GDR638	126/124M		14	3PMSF	TL	6.00	6.75	211	767	360	2339	14.5	239	1700	1600	126	S	
																				124	D
17.5	75	215/75R17.5	GTL919	135/133J		16	3PMSF	TL	6.00	6.75	211	767	360	2339	12.5	239	2180	2060	135	S	
																				133	D
17.5	75	215/75R17.5	GTR955	136/134K		16	3PMSF	TL	6.00	6.75	211	767	360	2339	12.5	239	2240	2120	136	S	
																				134	D
17.5	75	225/75R17.5	GAR820	129/127M		14	3PMSF	TL	6.75	6.00	226	783	366	2388	13.0	254	1850	1750	129	S	
			GSR236	129/127M		14	3PMSF	TL							13.0				127	D	
			GDR638	129/127M		14	3PMSF	TL								15.0					
17.5	75	235/75R17.5	GAR820	132/130M		14	3PMSF	TL	6.75	7.50	233	797	373	2431	13.5	262	2000	1900	132	S	
			GSR236	132/130M		14	3PMSF	TL							13.0				130	D	
			GDR638	132/130M		14	3PMSF	TL							15.0						
17.5	75	235/75R17.5	GTL919	143/141J	(146/146F)	16	3PMSF	TL	6.75	7.50	233	797	373	2431	13.0	262	2725	2575	143	S	
			GTR955	143/141K	(146/146F)	16	3PMSF	TL							13.0		(3000)	(3000)	141	D	
17.5	70	245/70R17.5	GAR820	136/134M		14	3PMSF	TL	7.50	6.75	248	789	367	2406	13.5	279	2240	2120	136	S	
			GSR236	136/134M		14	3PMSF	TL							13.0				134	D	
			GDR638	136/134M		14	3PMSF	TL							14.5						
17.5	70	245/70R17.5	GTL919	143/141J	(146/146F)	16	3PMSF	TL	7.50	6.75	248	789	367	2406	13.0	279	2725	2525	143	S	
			GTR955	143/141K	(146/146F)	16	3PMSF	TL							13.0		(3000)	(3000)	141	D	
19.5	70	245/70R19.5	GSR225	136/134M		16	3PMSF	TL	7.50	6.75	248	839	392	2559	14.0	279	2240	2120	136	S	
			GDR638	136/134M		16	3PMSF	TL							16.0				134	D	
			GT867	136/134M		16		TL							15.8						
19.5	70	245/70R19.5	GTL919	141/140J		18	3PMSF	TL	7.50	6.75	248	839	392	2559	14.0	279	2575	2500	141	S	
																				140	D
19.5	70	265/70R19.5	GSR225	140/138M		16	3PMSF	TL	7.50	6.75; 8.25	262	867	411	2644	14.0	295	2500	2360	140	S	
			GDR638	140/138M		16	3PMSF	TL							16.5				138	D	
19.5	70	265/70R19.5	GTL919	143/141J		18	3PMSF	TL	7.50	6.75; 8.25	262	867	411	2644	14.5	295	2725	2575	143	S	
			GTR923	143/141J		18	3PMSF	TL							14.5				141	D	
			GAU867 ^{VI}	143/141J		18	3PMSF	TL							15.5						
19.5	70	285/70R19.5	GSR225	146/145M		16	3PMSF	TL	8.25	7.50; 9.00	283	895	413	2730	14.5	318	3000	2900	146	S	
			GDR638	146/145M		16	3PMSF	TL							17.0				145	D	
19.5	70	285/70R19.5	GTL919	150/148J		18	3PMSF	TL	8.25	7.50; 9.00	283	895	413	2730	14.0	318	3350	3150	150	S	
																				148	D
19.5	50	435/50R19.5	GTL925	164J		20	3PMSF	TL	14.00	15.00	438	931	431	2821	12.9	-	5000	-	164	S	
19.5	45	445/45R19.5	GTL925	164J		22	3PMSF	TL	14.00	15.00	436	895	416	2730	12.9	-	5000	-	164	S	
20	100	9.00R20	GAM839	144/142K		16	M+S	TT	7.00	7.50; 7.00	259	1018	471	3105	15.7	297	2800	2650	144	S	
																				142	D
20	100	10.00R20	GAM839	146/143K		16	M+S	TT	7.50	8.00; 7.50	278	1052	493	3209	16.2	316	3000	2725	146	S	
																			143	D	

LOAD CAPACITY by AXLE (kg) and PRESSURE (bar and PSI)

BAR	4,50	4,75	5,00	5,25	5,50	5,75	6,00	6,25	6,50	6,75	7,00	7,25	7,50	7,75	8,00	8,25	8,50	8,75	9,00	
PSI	65	69	73	76	80	83	87	91	94	98	102	105	109	112	116	120	123	127	131	
	2010	2100	2180	2270	2350	2440	2520	2600	2680	2770	2850	2930	3000							
	3510	3660	3820	3970	4120	4270	4420	4560	4710	4850	5000	5140	5280							
	2410	2520	2620	2720	2820	2920	3020	3120	3220	3320	3410	3510	3600							
	4250	4440	4630	4810	4990	5170	5350	5530	5710	5880	6060	6230	6400							
			3480	3620	3760	3900	4030	4160	4300	4430	4560	4690	4820	4950	5070	5200	5330	5450		
			6580	6840	7100	7360	7620	7870	8120	8370	8620	8860	9100	9350	9590	9830	10060	10300		
	2140	2240	2330	2420	2510	2600	2690	2780	2860	2950	3040	3120	3200							
	3990	4160	4340	4510	4680	4850	5020	5190	5350	5510	5680	5840	6000							
	2410	2520	2620	2720	2820	2920	3020	3120	3220	3320	3410	3510	3600							
	4520	4720	4920	5110	5310	5500	5690	5880	6060	6250	6430	6620	6800							
	2330	2430	2530	2630	2730	2830	2930	3020	3120	3220	3310	3400								
	4370	4570	4760	4940	5130	5320	5500	5680	5860	6040	6220	6400								
			2880	2990	3100	3210	3320	3430	3540	3640	3750	3850	3960	4060	4160	4260	4360			
			5440	5650	5860	6060	6270	6470	6670	6870	7070	7270	7470	7660	7860	8050				
			2800	2910	3020	3130	3240	3350	3450	3560	3660	3770	3870	3970	4080	4180	4280	4380	4480	
			5300	5510	5720	5930	6130	6330	6540	6740	6940	7130	7330	7520	7720	7910	8100	8290	8480	
	2530	2640	2750	2860	2970	3080	3180	3290	3400	3500	3600	3700								
	4780	4990	5200	5410	5610	5810	6020	6220	6410	6610	6810	7000								
		2680	2800	2910	3020	3140	3250	3360	3470	3580	3690	3790	3900	4000						
		5090	5310	5520	5740	5950	6160	6370	6580	6790	6990	7200	7400	7600						
			3410	3540	3680	3810	3940	4070	4200	4330	4460	4580	4710	4840	4960	5080	5210	5330	5450	
			6440	6690	6950	7200	7450	7690	7940	8180	8420	8660	8900	9140	9370	9610	9840	10070	10300	
			2930	3050	3160	3280	3390	3510	3620	3730	3840	3950	4060	4170	4270	4380	4480			
			5550	5770	5990	6200	6420	6630	6840	7050	7260	7470	7670	7880	8080	8280	8480			
			3410	3540	3680	3810	3940	4070	4200	4330	4460	4580	4710	4840	4960	5080	5210	5330	5450	
			6440	6690	6950	7200	7450	7690	7940	8180	8420	8660	8900	9140	9370	9610	9840	10070	10300	
			3010	3130	3250	3360	3480	3600	3710	3820	3930	4050	4160	4270	4380	4480				
			5700	5920	6140	6360	6580	6800	7010	7230	7440	7650	7860	8070	8270	8480				
		3270	3400	3530	3660	3790	3920	4050	4170	4300	4420	4550	4670	4790	4910	5040	5150			
		6340	6600	6850	7110	7360	7610	7860	8100	8340	8580	8820	9060	9300	9530	9770	10000			
		3280	3420	3560	3700	3830	3970	4100	4230	4360	4490	4620	4750	4880	5000					
		6200	6460	6720	6980	7230	7480	7730	7980	8230	8480	8720	8960	9200	9440					
			3710	3850	3990	4130	4260	4400	4540	4670	4800	4930	5070	5200	5330	5450				
			7000	7270	7530	7790	8050	8310	8560	8820	9070	9320	9570	9810	10060	10300				
			3890	4040	4190	4340	4480	4620	4770	4910	5050	5190	5330	5460	5600	5740	5870	6000		
			7530	7810	8100	8380	8660	8940	9210	9480	9750	10020	10290	10550	10820	11080	11340	11600		
			4350	4510	4680	4840	5000	5160	5320	5480	5640	5790	5950	6100	6250	6400	6560	6700		
			8170	8490	8790	9100	9400	9710	10000	10300	10590	10880	11170	11460	11750	12040	12320	12600		
			6740	6990	7230	7470	7710	7940	8180	8410	8640	8870	9100	9330	9550	9780	10000			
			6740	6990	7230	7470	7710	7940	8180	8410	8640	8870	9100	9330	9550	9780	10000			
			3640	3770	3910	4050	4180	4320	4450	4580	4710	4840	4970	5100	5230	5350	5480	5600		
			6880	7140	7400	7660	7910	8170	8420	8660	8910	9160	9400	9640	9880	10120	10360	10600		
		4030	4190	4350	4500	4660	4810	4970	5120	5270	5420	5570	5710	5860	6000					
		7320	7610	7900	8180	8460	8740	9010	9290	9560	9830	10100	10370	10640	10900					







TECHNICAL DATA

TECHNICAL SPECIFICATIONS																	Per Tire					
Bead	Series	Size	Pattern	Index	Index 2	PR		Type		Approved Rim					TD		Load Single	Load Dual	Index	S=Single	D=Dual	
20	100	11.00R20	GAM839	152/149K		16	M+S	TT	8.00	8.50; 8.00	293	1082	507	3300	16.0	330	3550	3250	152	S	149	D
20	100	12.00R20	GAM839	156/153K		20	M+S	TT	8.50	8.50; 9.00	315	1122	526	3431	16.0	344	4000	3650	156	S	153	D
20	100	14.00R20	GA0897	164/161J		20		TL	10.00		375	1253	571	3822	19.0	426	5000	4625	164	S	161	D
22.5	90	9R22.5	GAL817	136/134M		14		TL	6.75	6.00-7.50	229	974	457	2971	13.8	256	2240	2120	136	S	134	D
22.5	90	10R22.5	GAL817	144/142M		14		TL	7.50	6.75	254	1020	476	3111	14.8	286	2800	2650	144	S	142	D
			GDR688	144/142M		14	3PMSF	TL							15.8				142	D		
22.5	90	11R22.5	GSR225	148/145M		16	3PMSF	TL	8.25	7.50	279	1050	489	3203	15.3	314	3150	2900	148	S		
			GT867	148/145J		16	3PMSF	TL							18.7				145	D		
			GAU867 ^{VI}	148/145J		16	3PMSF	TL							18.7							
			GDR655	148/145M		16	3PMSF	TL							21.0							
			GDM686	148/145J		16	3PMSF	TL							22.6							
22.5	90	11R22.5	GSR237	149/146J		16	3PMSF	TL	8.25	7.50	279	1054	491	3215	16.0	314	3250	3000	149	S	146	D
22.5	90	12R22.5	GSR225	152/149L		16	3PMSF	TL	9.00	8.25	300	1084	507	3306	15.8	338	3550	3250	152	S		
			GSR237	152/149L		16	3PMSF	TL							17.5				149	D		
			GDR655	152/149L		16	3PMSF	TL							24.0							
22.5	90	12R22.5	GDM686	152/148K		16	3PMSF	TL	9.00	8.25	300	1084	507	3306	23.1	338	3550	3150	152	S	148	D
22.5	90	13R22.5	GAM831	156/150K	(154/150 L)	18	3PMSF	TL	9.75	9.00	320	1124	521	3428	18.2	360	4000	3350	156	S		
			GDM686+	156/150K		18	3PMSF	TL							23.1		(3750)	(3350)	150	D		
22.5	80	295/80R22.5	GSR225	154/149M		18	3PMSF	TL	9.00	8.25	298	1044	487	3184	16.5	335	3750	3250	154	S		
			GSR237	154/149M		18	3PMSF	TL							16.5		(3550)	(3250)	149	D		
			GAM837	154/149K	(152/149L)	18	3PMSF	TL							17.5							
22.5	80	295/80R22.5	GAU867 ^{VI}	154/150J		18	M+S	TL	9.00	8.25	298	1044	487	3184	18.7	335	3750	3350	154	S	150	D
22.5	80	295/80R22.5	GDL617	152/148M		16	3PMSF	TL	9.00	8.25	298	1044	487	3184	17.5	335	3550	3150	152	S		
			GDC629	152/148M		16	3PMSF	TL							17.2				148	D		
22.5	80	295/80R22.5	GDR655	152/149M		18	3PMSF	TL	9.00	8.25	298	1044	487	3184	21.1	335	3550	3250	152	S		
			GDR665+	152/149M		18	3PMSF	TL							21.1				149	D		
			GDR675	152/149M		18	3PMSF	TL							20.0							
			GDM686	152/149K		18	3PMSF	TL							22.6							
			GT867	152/149J		18	M+S	TL							18.7							
22.5	80	315/80R22.5	GSR225	158/150L	(154/150M)	20	3PMSF	TL	9.00	8.25	312	1076	500	3282	16.8	351	4250	3350	158	S		
			GSR237	158/150L	(154/150M)	20	3PMSF	TL							17.5		(3750)	(3350)	150	D		
			GSW226	158/150L	(154/150M)	18	3PMSF	TL							16.8							
			GAM831	158/150K	(154/150L)	18	3PMSF	TL							18.2							
			GT867	158/150J		18	M+S	TL							18.7							
			GDM686	158/150K		20	3PMSF	TL							23.1							
			GDR621+	158/150L	(154/150M)	20	3PMSF	TL							23.1							
22.5	80	315/80R22.5	GDL617	156/150L	(154/150M)	18	3PMSF	TL	9.00	9.75	312	1076	500	3282	18.4	351	4000	3350	156	S		
			GDR655+	156/150L	(154/150M)	18	3PMSF	TL							21.0		(3750)	(3350)	150	D		
			GDR665	156/150L	(154/150M)	18	3PMSF	TL							21.0							
			GDR675	156/150L	(154/150M)	18	3PMSF	TL							20.0							
			GDM687	156/150K		18	3PMSF	TL							20.0							
22.5	70	255/70R22.5	GAL817	140/137M		16		TL	7.50	6.75; 8.25	255	930	435	2837	14.8	287	2500	2300	140	S	137	D

LOAD CAPACITY by AXLE (kg) and PRESSURE (bar and PSI)

BAR	4,50	4,75	5,00	5,25	5,50	5,75	6,00	6,25	6,50	6,75	7,00	7,25	7,50	7,75	8,00	8,25	8,50	8,75	9,00	
PSI	65	69	73	76	80	83	87	91	94	98	102	105	109	112	116	120	123	127	131	
				4610	4790	4960	5130	5300	5470	5640	5810	5970	6140	6300	6460	6620	6780	6940	7100	
				8450	8770	9080	9400	9710	10020	10330	10630	10940	11240	11530	11830	12130	12420	12710	13000	
				5190	5390	5590	5780	5970	6160	6350	6540	6730	6910	7100	7280	7460	7650	7830	8000	
				9470	9830	10190	10540	10900	11250	11590	11930	12270	12610	12950	13280	13610	13950	14270	14600	
	6310	6590	6870	7140	7410	7680	7940	8210	8470	8730	8990	9240	9500	9750	10000					
	11680	12190	12700	13210	13710	14200	14700	15180	15670	16150	16630	17100	17570	18040	18500					
				3000	3120	3240	3360	3470	3590	3700	3820	3930	4040	4150	4260	4370	4480			
				5680	5910	6130	6350	6570	6790	7010	7220	7440	7650	7860	8070	8270	8480			
				3660	3810	3950	4100	4240	4380	4520	4660	4800	4930	5070	5210	5340	5470	5600		
				6930	7210	7480	7750	8020	8290	8550	8810	9070	9330	9590	9840	10100	10350	10600		
				3960	4120	4290	4450	4610	4770	4930	5090	5240	5400	5550	5700	5860	6010	6160	6300	
				7280	7580	7890	8190	8480	8780	9070	9360	9640	9930	10210	10490	10770	11050	11330	11600	
				4060	4220	4380	4540	4700	4860	5010	5160	5320	5470	5620	5770	5920	6060	6210	6360	6500
				7500	7800	8090	8390	8680	8960	9250	9530	9810	10090	10370	10650	10920	11190	11460	11730	12000
				4610	4790	4960	5130	5300	5470	5640	5810	5970	6140	6300	6460	6620	6780	6940	7100	
				8450	8770	9080	9400	9710	10020	10330	10630	10940	11240	11530	11830	12130	12420	12710	13000	
				4960	5130	5300	5470	5640	5810	5970	6140	6300	6460	6620	6780	6940	7100			
				8500	8800	9110	9410	9710	10010	10310	10600	10890	11180	11470	11750	12040	12600			
				5120	5320	5530	5730	5920	6120	6310	6510	6700	6890	7080	7270	7450	7640	7820	8000	
				8560	8900	9240	9580	9910	10240	10560	10890	11210	11530	11850	12160	12470	12780	13090	13400	
				4710	4910	5100	5290	5490	5680	5870	6050	6240	6420	6610	6790	6970	7150	7330	7500	
				8160	8500	8840	9170	9510	9840	10160	10480	10810	11130	11440	11760	12070	12380	12690	13000	
				4710	4910	5100	5290	5490	5680	5870	6050	6240	6420	6610	6790	6970	7150	7330	7500	
				8410	8760	9110	9460	9800	10140	10480	10810	11140	11470	11800	12120	12440	12760	13080	13400	
				4460	4640	4830	5010	5190	5370	5550	5730	5910	6080	6250	6430	6600	6770	6940	7100	
				7910	8240	8570	8890	9210	9530	9850	10160	10470	10780	11090	11400	11700	12000	12300	12600	
				4610	4780	4960	5130	5300	5470	5640	5810	5970	6140	6300	6460	6630	6790	6950	7100	
				8430	8750	9070	9390	9700	10010	10320	10620	10930	11230	11530	11830	12120	12420	12710	13000	
							5930	6140	6350	6550	6750	6950	7150	7350	7540	7740	7930	8120	8310	8500
							9110	9460	9800	10140	10480	10810	11140	11470	11800	12120	12440	12760	13080	13400
				5440	5650	5850	6060	6260	6460	6650	6850	7050	7240	7430	7630	7820	8000			
				9110	9460	9800	10140	10480	10810	11140	11470	11800	12120	12440	12760	13080	13400			
	3090	3230	3360	3490	3620	3750	3880	4010	4140	4270	4390	4520	4640	4760	4880	5000				
	5680	5930	6180	6420	6660	6900	7140	7370	7610	7840	8070	8300	8530	8750	8980	9200				

TECHNICAL DATA

TECHNICAL SPECIFICATIONS																	Per Tire					
Bead	Series	Size	Pattern	Index	Index 2	PR		Type		Approved Rim					TD	Min Dual	Load Single	Load Dual	Index	S=Single	D=Dual	
22.5	70	275/70R22.5	GSR225	148/145M	(152/148J)	16	3PMSF	TL	8.25	7.50	276	958	446	2922	15.0	311	3150	2900	148	S		
			GSR237	148/145M	(152/148J)	16	3PMSF	TL								15.0		(3550)	(3150)	145	D	
22.5	70	275/70R22.5	GAU861	150/145J	(154/148E)	16	3PMSF	TL	8.25	7.50	276	958	446	2922	20.2	311	3350	2900	150	S		
			GT867	150/145J	(154/148E)	16	M+S	TL								18.7		(3750)	(3150)	145	D	
22.5	70	275/70R22.5	GAU867 ^{VI}	152/148J	(150/148K)	16	3PMSF	TL	8.25	7.50	276	958	446	2922	18.7	311	3550	3150	152	S		
			GAU861	152/148J	(150/148K)	16	3PMSF	TL								20.2		(3350)	(3150)	148	D	
22.5	70	305/70R22.5	GT867	152/150J	(154/150E)	16	M+S	TL	9.00	8.25	305	1000	462	3049	19.0	344	3550	3350	152	S		
																		(3750)	(3350)	150	D	
22.5	70	315/70R22.5	GSR225	156/150L	(154/150M)	18	3PMSF	TL	9.00	9.75	312	1014	467	3093	15.5	351	4000	3350	154	S		
			GSR237	156/150L	(154/150M)	18	3PMSF	TL								15.0		(3750)	(3350)	150	D	
			GSW226	156/150L	(154/150M)	18	3PMSF	TL								15.5						
			GAM837	156/150K	(154/150L)	18	3PMSF	TL								17.5						
22.5	70	315/70R22.5	GDL617	154/150L	(152/148M)	18	3PMSF	TL	9.00	9.75	312	1014	467	3093	17.5	351	3750	3350	156	S		
			GDL617 ECO	154/150L	(152/148M)	18	3PMSF	TL								17.5		(3550)	(3150)	150	D	
			GDR621+	154/150L	(152/148M)	18	3PMSF	TL								21.0						
			GDR655+	154/150L	(152/148M)	18	3PMSF	TL								21.0						
			GDR675	154/150L	(152/148M)	18	3PMSF	TL								19.0						
22.5	65	385/65R22.5	GSW226	164K	(160L)	20	3PMSF	TL	11.75	12.25	389	1072	501	3248	16.0	-	5000	-	164	S		
			GSR259	164K	(160L)	20	3PMSF	TL								15.0		(4500)				
22.5	65	385/65R22.5	GAM851	160K	(158L)	18	3PMSF	TL	11.75	12.25	389	1072	501	3248	17.0	-	4500		160	S		
																		(4250)				
22.5	65	385/65R22.5	GTR955	164K	(158L)	20	3PMSF	TL	11.75	12.25	389	1072	501	3248	15.5	-	5000		164	S		
			GTL919(+)	164K	(158L)	20	3PMSF	TL								15.5		(4250)				
			GAM851	164K	(158L)	20	3PMSF	TL								17.0						
22.5	65	425/65R22.5	GAM851	165K		20	3PMSF	TL	13.00	11.75; 12.25	430	1124	525	3406	18.0	-	5150	-	165	S		
			GTL919	165K		20	3PMSF	TL								15.3						
22.5	65	445/65R22.5	GAM851	169K		20	3PMSF	TL	14.00	12.25; 13.00	454	1150	537	3485	18.0	-	5800	-	169	S		
22.5	60	295/60R22.5	GSR225	150/147L		18	3PMSF	TL	9.00	9.75	292	932	433	2842.6	15.0	335	3350	3075	150	S		
			GSR237	150/147L		18	3PMSF	TL								15.0		(3250)	(3000)	147	D	
			GDL617	150/147K	(149/146L)	18	3PMSF	TL								18.0						
			GDR675	150/147K	(149/146L)	18	3PMSF	TL								18.0						
22.5	60	315/60R22.5	GSR225	154/148L		20	3PMSF	TL	9.00	9.75	313	950	443	2898	13.5	344	3750	3150	154	S		
																				148	D	
22.5	60	315/60R22.5	GSR237	156/150L		20	3PMSF	TL	9.00	9.75	313	950	443	2898	13.5	344	4000	3350	156	S		
																				150	D	
22.5	60	315/60R22.5	GDL617	152/148L		18	3PMSF	TL	9.00	9.75	313	950	443	2898	18.2	344	3550	3150	152	S		
			GDR675	152/148L		18	3PMSF	TL	9.00							18.0				148	D	
22.5	55	385/55R22.5	GSW226	158L	(160J)	18	3PMSF	TL	12.25	11.75	386	996	465	3018	15.5	-	4250	-	158	S		
			GSR259	158L	(160K)	18	3PMSF	TL								14.5		(4500)				
22.5	55	385/55R22.5	GTL919	160K	(158L)	20	3PMSF	TL	12.25	11.75	386	996	465	3018	14.8	-	4500	-	160	S		
			GTR955	160K	(158L)	20	3PMSF	TL										(4250)				
22.5	55	385/55R22.5	GTR955	164K	(158L)	20	3PMSF	TL	12.25	11.75	386	996	465	3018	14.8	-	5000		164	S		
																		(4250)				
22.5	50	355/50R22.5	GSR237	156L		20	3PMSF	TL	11.75	-	361	928	436	2812	12.0	-	4000	-	156	S		
24	100	12.00R24	GAM833	160/156K		20	M+S	TT	8.5	9.0	315	1225	541	3736	15.0	360	4500	4000	160	S		
																				156	D	
24	95	325/95R24	GAM833	162/160K		22	M+S	TL/TT	9.00	8.5	325	1228	541	3745	17.0	374	4750	4500	162	S		
																				160	D	

LOAD CAPACITY by AXLE (kg) and PRESSURE (bar and PSI)

BAR	4,50	4,75	5,00	5,25	5,50	5,75	6,00	6,25	6,50	6,75	7,00	7,25	7,50	7,75	8,00	8,25	8,50	8,75	9,00
PSI	65	69	73	76	80	83	87	91	94	98	102	105	109	112	116	120	123	127	131
				4090	4250	4400	4550	4700	4860	5000	5150	5300	5450	5590	5740	5880	6020	6160	6300
				7530	7810	8100	8380	8660	8940	9210	9480	9750	10020	10290	10550	10820	11080	11340	11600
				4350	4510	4680	4840	5000	5160	5320	5480	5640	5790	5950	6100	6250	6400	6560	6700
				7530	7810	8100	8380	8660	8940	9210	9480	9750	10020	10290	10550	10820	11080	11340	11600
				4610	4780	4960	5130	5300	5470	5640	5810	5970	6140	6300	6460	6630	6790	6950	7100
				7910	8240	8570	8890	9210	9530	9850	10160	10470	10780	11090	11400	11700	12000	12300	12600
				4610	4790	4960	5130	5300	5470	5640	5810	5970	6140	6300	6460	6620	6780	6940	7100
				8190	8500	8800	9110	9410	9710	10010	10310	10600	10890	11180	11470	11750	12040	12320	12600
				5190	5390	5590	5780	5970	6160	6350	6540	6730	6910	7100	7280	7460	7650	7830	8000
				8690	9020	9350	9680	10000	10320	10640	10950	11260	11570	11880	12190	12500	12800	13100	13400
				4870	5050	5240	5420	5600	5780	5960	6130	6310	6480	6660	6830	7000	7170	7340	7500
				8690	9020	9350	9680	10000	10320	10640	10950	11260	11570	11880	12190	12500	12800	13100	13400
				6490	6740	6980	7220	7460	7700	7940	8180	8410	8640	8870	9100	9330	9560	9780	10000
				5840	6060	6280	6500	6720	6930	7150	7360	7570	7780	7990	8190	8400	8600	8800	9000
				6490	6740	6980	7220	7460	7700	7940	8180	8410	8640	8870	9100	9330	9560	9780	10000
				7190	7460	7730	8000	8260	8520	8780	9040	9300	9550	9800	10060	10300			
				7810	8100	8380	8660	8940	9210	9480	9760	10020	10290	10560	10820	11080	11350	11600	
				4350	4510	4680	4840	5000	5160	5320	5480	5640	5790	5950	6100	6250	6400	6560	6700
				7980	8280	8590	8880	9180	9470	9770	10050	10340	10620	10910	11190	11470	11750	12030	12300
				4870	5050	5240	5420	5600	5780	5960	6130	6310	6480	6660	6830	7000	7170	7340	7500
				8170	8490	8790	9100	9400	9710	10000	10300	10590	10880	11170	11460	11750	12040	12320	12600
				5200	5390	5590	5780	5980	6170	6360	6540	6730	6910	7100	7280	7460	7640	7820	8000
				8690	9020	9350	9680	10000	10320	10640	10950	11260	11570	11880	12190	12500	12800	13100	13400
				4610	4780	4960	5130	5300	5470	5640	5810	5970	6140	6300	6460	6630	6790	6950	7100
				8170	8490	8790	9100	9400	9710	10000	10300	10590	10880	11170	11460	11750	12040	12320	12600
		5330	5560	5780	6000	6220	6430	6650	6860	7070	7280	7490	7690	7900	8100	8300	8500		
				5840	6060	6280	6500	6720	6930	7150	7360	7570	7780	7990	8190	8400	8600	8800	9000
				6490	6740	6980	7220	7460	7700	7940	8180	8410	8640	8870	9100	9330	9560	9780	10000
				5200	5390	5590	5780	5980	6170	6360	6540	6730	6910	7100	7280	7460	7640	7820	8000
				6350	6580	6810	7040	7260	7480	7710	7920	8140	8360	8570	8790	9000			
				11290	11700	12110	12510	12910	13310	13700	14090	14480	14860	15240	15620	16000			
				6710	6950	7190	7430	7670	7900	8130	8360	8590	8820	9050	9280	9500			
				12710	13170	13620	14070	14520	14970	15410	15850	16280	16720	17150	17580	18000			

GITI TIRES: DESIGNED FOR LONG-TERM USE

While many people just assume that tires have just one stage of life, Giti tires are created for users to extract their maximum value – through their initial use, regrooving, and retreading stages. After retreading, it is even possible to regroove again for additional added driving. With this long-term usage mindset, you can realise the greatest cost/kilometer savings while still maintaining reliable tire performance.

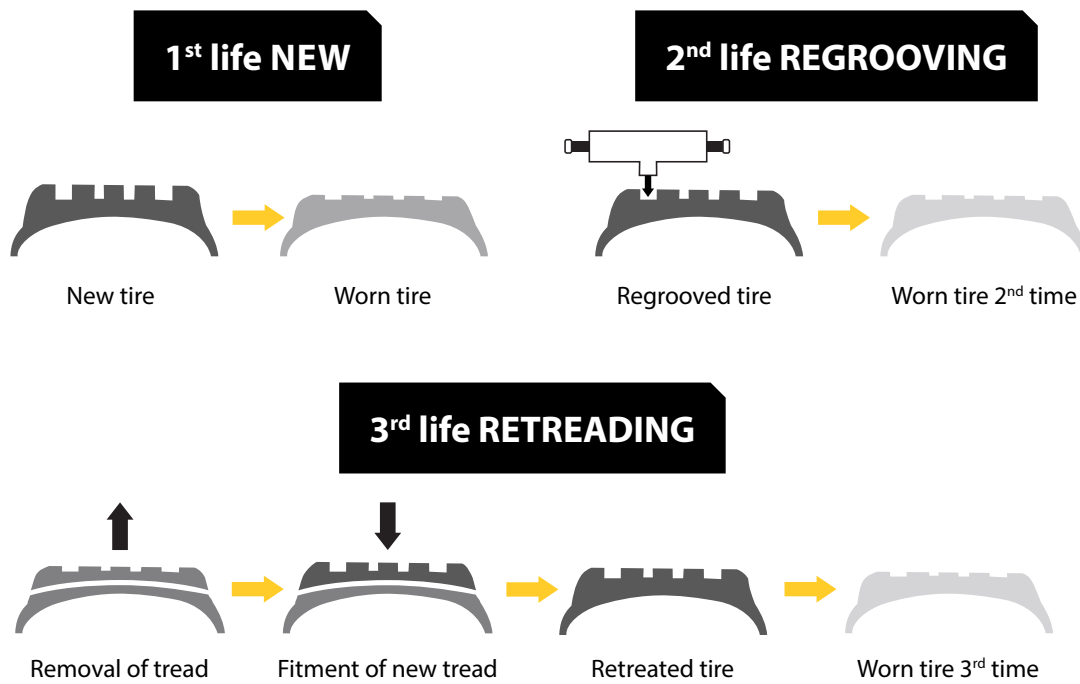

REGROOVING

- > Ensures that the end consumer can extract maximum value from Giti tires
- > Maximises utilisation of available tread and under-tread rubber
- > Prolongs use of the tire in its most fuel-efficient state

BLADE TYPE USAGE REFERENCE

BLADE TYPE	R1	R2	R3	R4	R5
BLADE DIMENSIONS	mm	mm	mm	mm	mm
A	3	5	6	8	10
B	7	7	10	12	12
C	5	8	15	16	18
D	21	21	23	25	24

If you have any more questions, your Giti technical sales representative can help answer them.

REGROOVING INSTRUCTIONS

GSR225

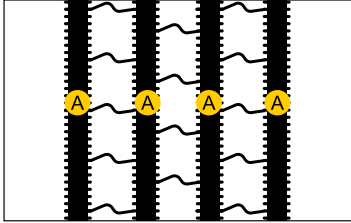

Max. regrooving depth: 3 mm

Size	A (mm)
245/70R19.5	7-9
265/70R19.5	7-9
285/70R19.5	7-9
11R22.5	9-11
12R22.5	9-11
275/70R22.5	9-11
295/80R22.5	9-11
295/60R22.5	9-11
315/60R22.5	9-11
315/70R22.5	9-11
315/80R22.5	9-11

GSR236

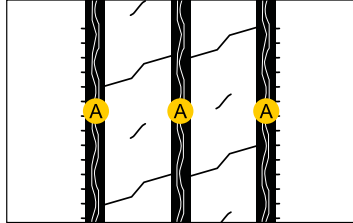

Max. regrooving depth: 2 mm

Size	A (mm)	B (mm)
215/75R17.5	7-9	5-7

GSR237

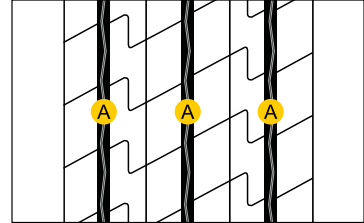

Max. regrooving depth: 3 mm

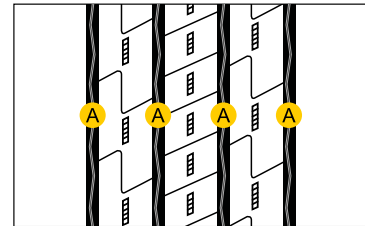

Max. regrooving depth: 3 mm

Size	A (mm)
295/80R22.5	9-11
315/70R22.5	9-11
355/50R22.5	9-11

GSR259

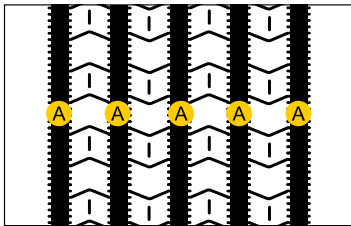

Max. regrooving depth: 3 mm

Size	A (mm)
385/55R22.5	9-11
385/65R22.5	9-11

GDR675

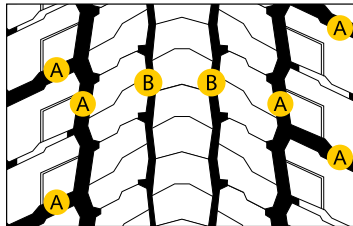

Max. regrooving depth: 3 mm

Size	A (mm)	B (mm)
295/80R22.5	6-8	3-5
315/60R22.5	6-8	3-5
315/70R22.5	6-8	3-5
315/80R22.5	6-8	3-5

GDR655 / GDR655+

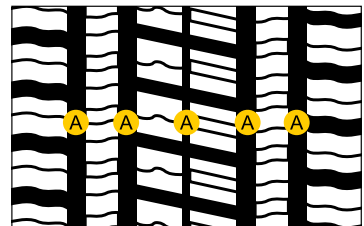

Max. regrooving depth: 3 mm

Size	A (mm)
GDR655	
11R22.5	6-8
295/80R22.5	6-8
315/70R22.5	6-8
315/80R22.5	6-8
GDR655+	
315/70R22.5	6-8
315/80R22.5	6-8

REGROOVING INSTRUCTIONS

GDR665 / GDR665+

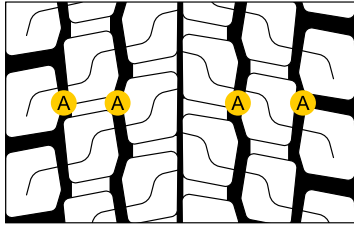

Max. regrooving depth: 3 mm

Size	A (mm)
GDR665	
295/80R22.5	7-9
315/80R22.5	7-9
GDR665+	
295/80R22.5	7-9

GTR955

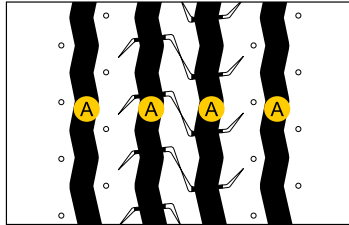

Max. regrooving depth:
2 mm for R17.5 and 3 mm for R22.5

Size	A (mm)
215/75R17.5	6-8
235/75R17.5	6-8
245/70R17.5	6-8
385/55R22.5	9-11
385/65R22.5	9-11

GAL817

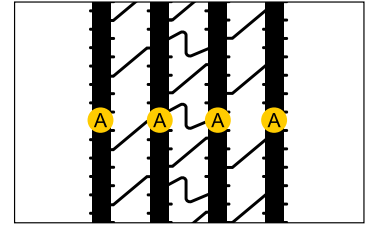

Max. regrooving depth: 3 mm

Size	A (mm)
9R22.5	8-10
10R22.5	8-10

GDC629

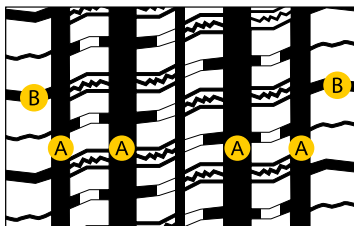

Max. regrooving depth: 3 mm

Size	A (mm)	B (mm)
295/60R22.5	6-7	3-5

GDL617 / GDL617 ECO

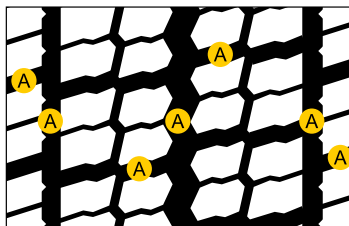

Max. regrooving depth: 3 mm

Size	A (mm)
GDL617	
295/60R22.5	6-7
295/80R22.5	6-7
315/60R22.5	6-7
315/70R22.5	6-7
315/80R22.5	6-7
GDL617 ECO	
315/70R22.5	6-7

GTL919 / GTL919+

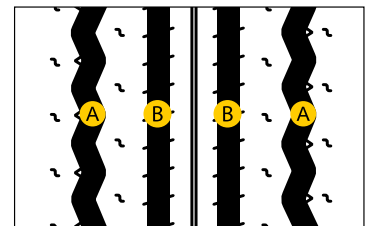

Max. regrooving depth:
2 mm for R17.5 and 3 mm for R22.5

Size	A (mm)	B (mm)
GTL919		
215/75R17.5	6-8	5-7
235/75R17.5	6-8	5-7
245/70R17.5	7-9	5-7
245/70R19.5	7-9	5-7
265/70R19.5	7-9	5-7
285/70R19.5	7-9	5-7
385/55R22.5	9-11	8-9
385/65R22.5	9-11	8-9
425/65R22.5	9-11	8-9
GTL919+		
385/55R22.5	9-11	8-9
385/65R22.5	9-11	8-9

GTL925

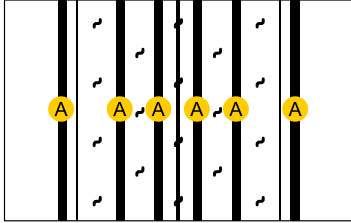

Max. regrooving depth: 3 mm

Size	A (mm)
435/50R19.5	7-10
445/45R19.5	7-10

GAC821

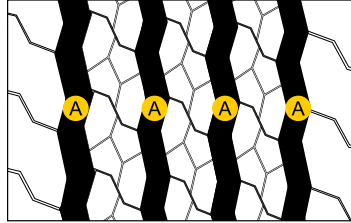

Max. regrooving depth: 3 mm

Size	A (mm)
295/80R22.5	7-9

GAR820

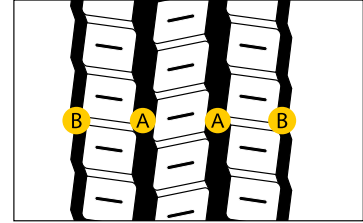

Max. regrooving depth: 2 mm

Size	A (mm)	B (mm)
9.5R17.5	7-9	5-7
205/75R17.5	7-9	5-7
215/75R17.5	7-9	5-7
225/75R17.5	7-9	5-7
235/75R17.5	7-9	5-7
245/70R17.5	7-9	5-7

GDR638

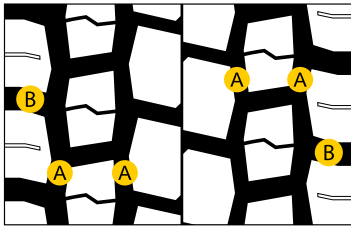

Max. regrooving depth:
2 mm for R17.5 and 3 mm for R19.5

Size	A (mm)	B (mm)
205/75R17.5	6-8	7-9
215/75R17.5	6-8	7-9
225/75R17.5	6-8	7-9
235/75R17.5	6-8	7-9
245/70R17.5	6-8	7-9
245/70R19.5	8-10	9-11
265/70R19.5	8-10	9-11
285/70R19.5	8-10	9-11

GAM831

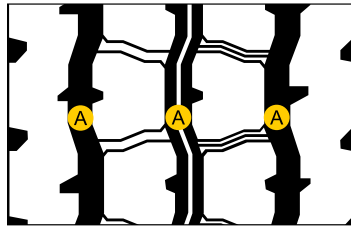

Max. regrooving depth: 3 mm

Size	A (mm)
13R22.5	8-10
315/80R22.5	8-10

GAM837

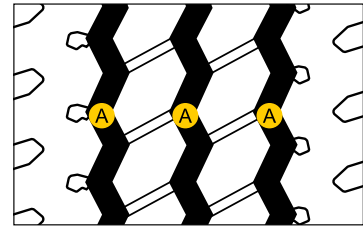

Max. regrooving depth: 3 mm

Size	A (mm)
295/80R22.5	7-9
315/70R22.5	7-9

REGROOVING INSTRUCTIONS

GAM839

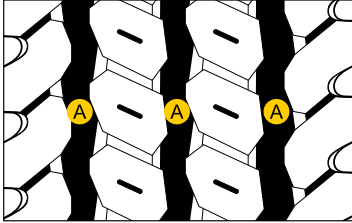

Max. regrooving depth: 3 mm

Size	A (mm)
9.00R20	8-10
10.00R20	8-10
11.00R20	8-10
12.00R20	8-10
11R22.5	8-10

GDM686 / GDM686+

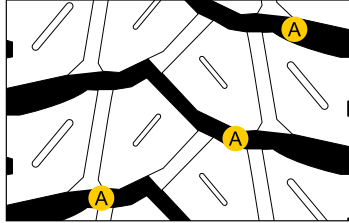

Max. regrooving depth: 3 mm

Size	A (mm)
11R22.5	10-12
12R22.5	10-12
13R22.5	10-12
295/80R22.5	10-12
315/80R22.5	10-12

GAM851

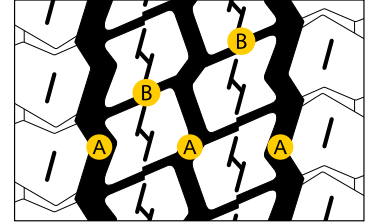

Max. regrooving depth: 3 mm

Size	A (mm)	B (mm)
385/65R22.5	10-12	7-9
425/65R22.5	10-12	7-9
445/65R22.5	10-12	7-9

GAU861

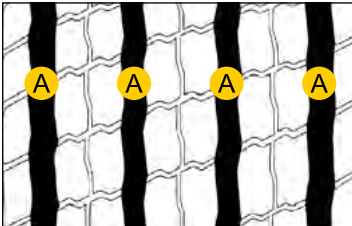

Max. regrooving depth: 3 mm

Size	A (mm)
275/70R22.5	7-9

GT867

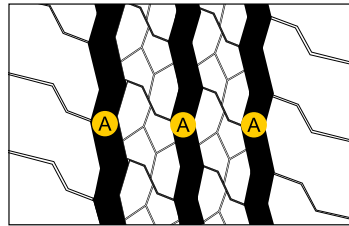

Max. regrooving depth: 3 mm

Size	A (mm)
245/70R19.5	6-8
11R22.5	7-9
275/70R22.5	7-9
295/80R22.5	7-9
305/70R22.5	7-9
315/80R22.5	7-9

GAU867^{V1}

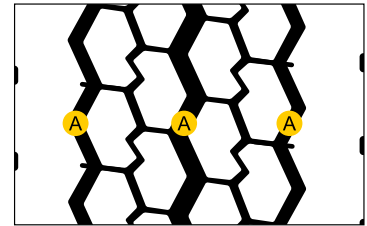

Max. regrooving depth:
2 mm for R17.5 and 3 mm for R19.5, R22.5

Size	A (mm)
215/75R17.5	6-8
265/70R19.5	6-8
11R22.5	7-9
275/70R22.5	7-9
295/80R22.5	7-9

GSW226

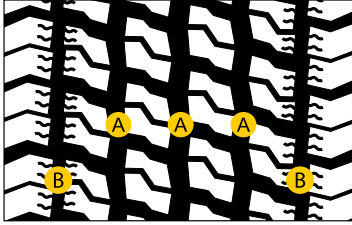

Max. regrooving depth: 3 mm

Size	A (mm)	B (mm)
315/70R22.5	8-10	7-9
315/80R22.5	8-10	7-9
385/55R22.5	8-10	7-9
385/65R22.5	8-10	7-9

GDR621 / GDR621+

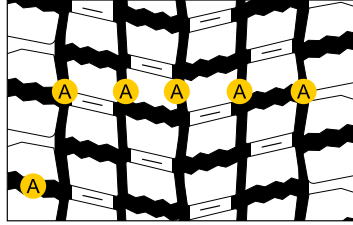

Max. regrooving depth: 3 mm

Size	A (mm)
315/70R22.5	7-9
315/80R22.5	7-9



The information contained in this catalogue is for general information purposes only. Every effort has been made to ensure the product information provided is accurate and up to date at the time of going to press. We reserve the right to make changes to the product range, descriptions, markings and make modifications or substitutions without prior notice.

Version 23.1 UK